

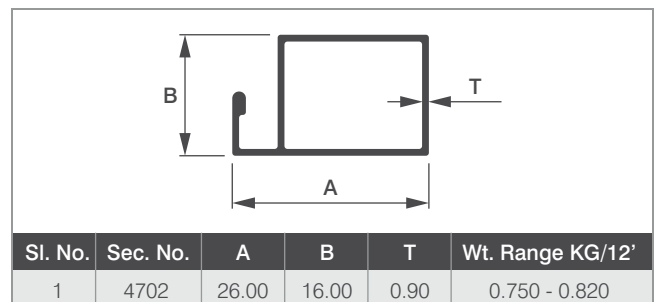

MESH SECTIONS

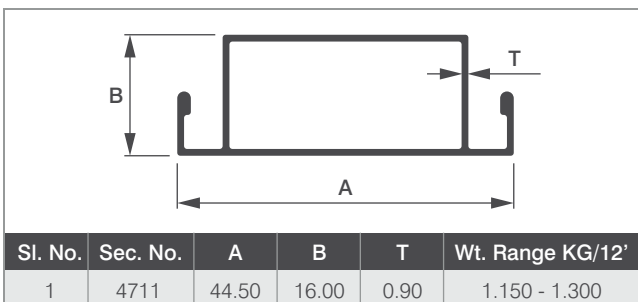

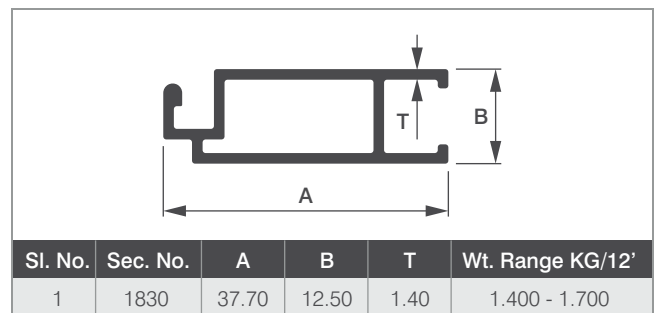
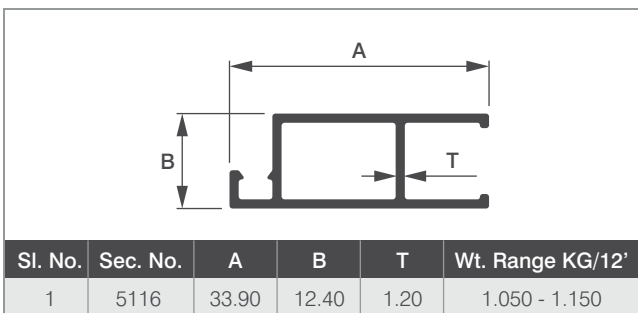
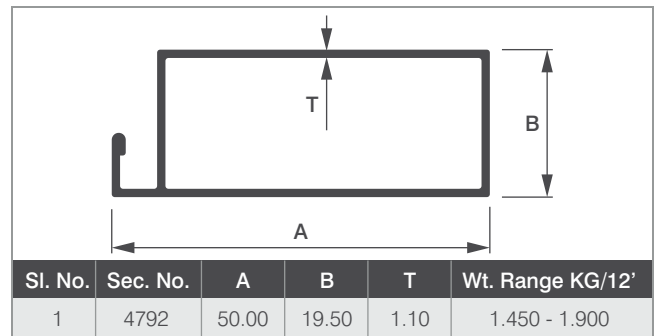
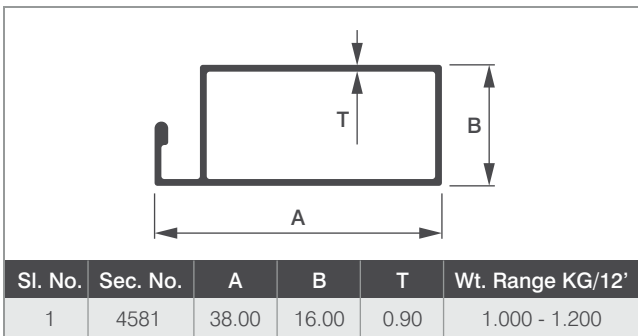
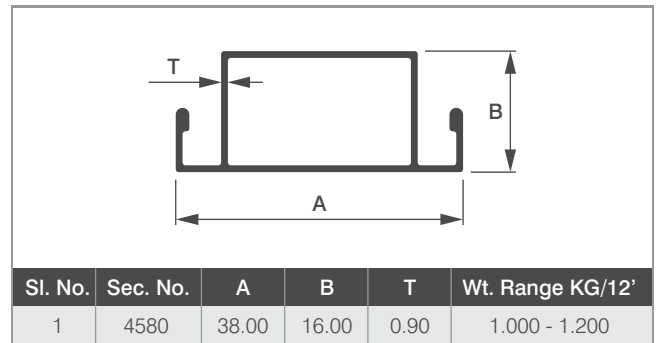
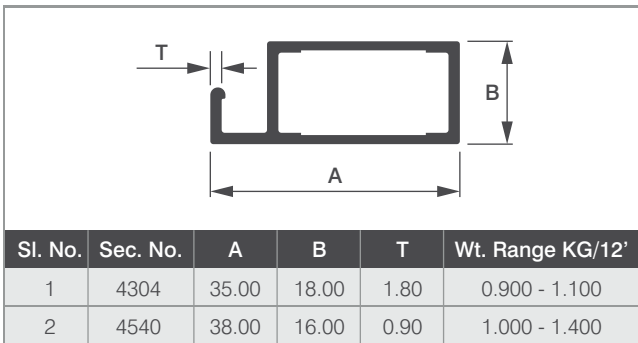
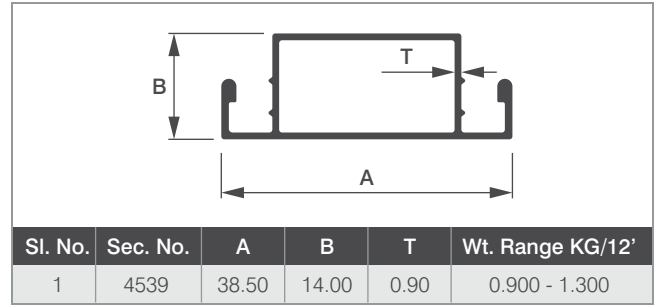
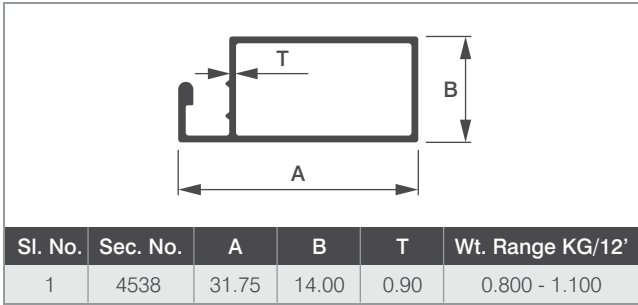

MESH SECTIONS

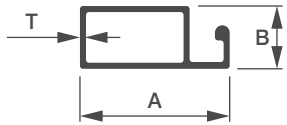

Sl. No.	Sec. No.	A	B	T	Wt. Range KG/12'
1	4704	19.80	8.30	0.80	0.440 - 0.480

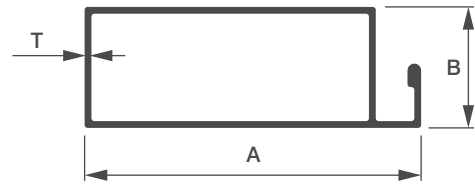

Sl. No.	Sec. No.	A	B	T	Wt. Range KG/12'
1	4703	44.50	16.00	0.90	1.050 - 1.150

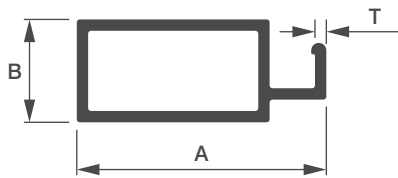

Sl. No.	Sec. No.	A	B	T	Wt. Range KG/12'
1	4129	33.00	12.60	1.20	1.200 - 1.350
2	4529	19.60	8.30	0.90	0.400 - 0.600

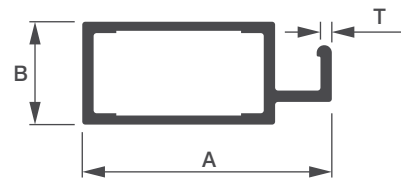

Sl. No.	Sec. No.	A	B	T	Wt. Range KG/12'
1	4129/R	33.00	13.60	1.20	1.000 - 1.200

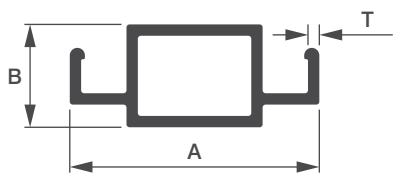

Sl. No.	Sec. No.	A	B	T	Wt. Range KG/12'
1	4130	33.00	13.60	1.50	1.300 - 1.500

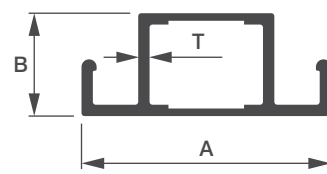

Sl. No.	Sec. No.	A	B	T	Wt. Range KG/12'
1	4305	35.00	18.00	0.90	1.100 - 1.300

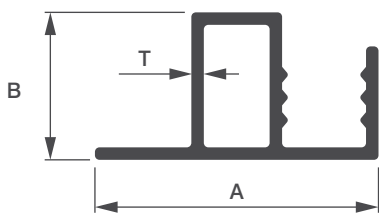

Sl. No.	Sec. No.	A	B	T	Wt. Range KG/12'
1	4695	25.00	13.00	1.10	0.710 - 0.780

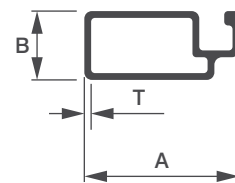

Sl. No.	Sec. No.	A	B	T	Wt. Range KG/12'
1	4560	20.50	9.10	0.90	0.525 - 0.700



MESH SECTIONS

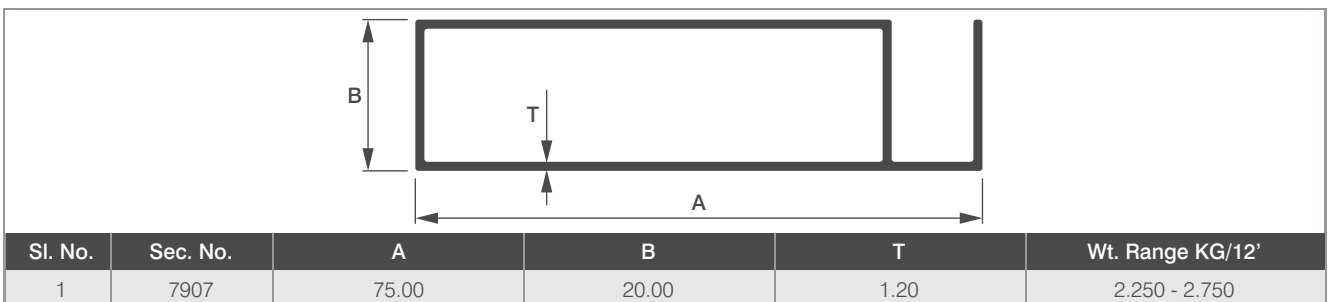
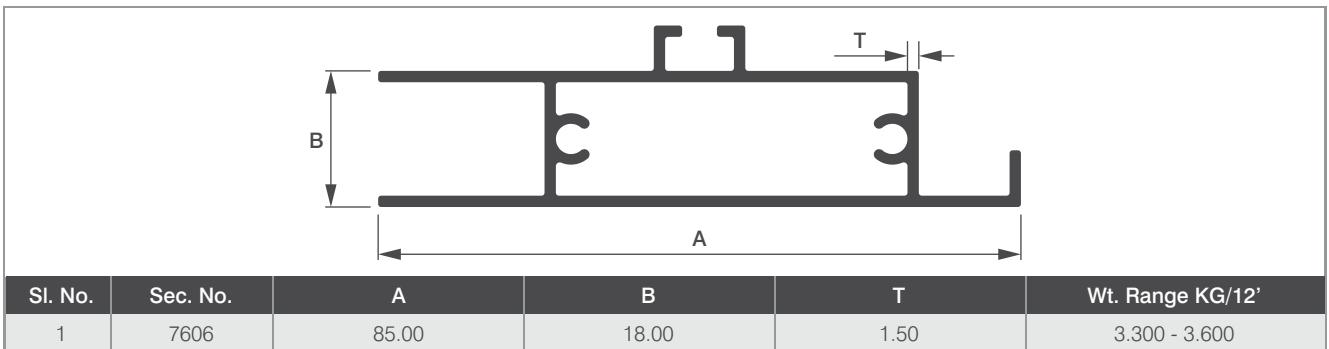
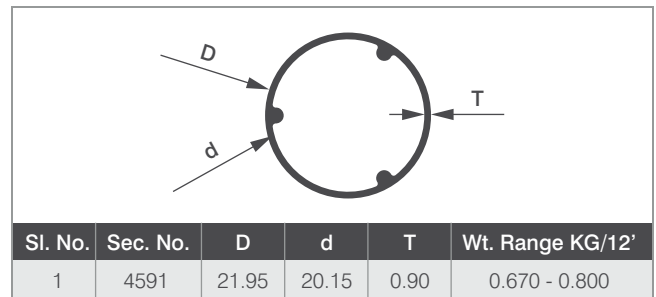
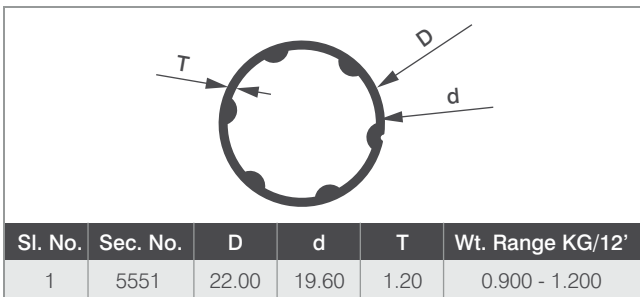
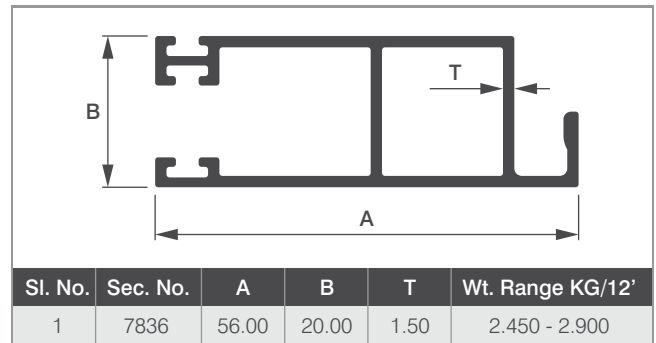
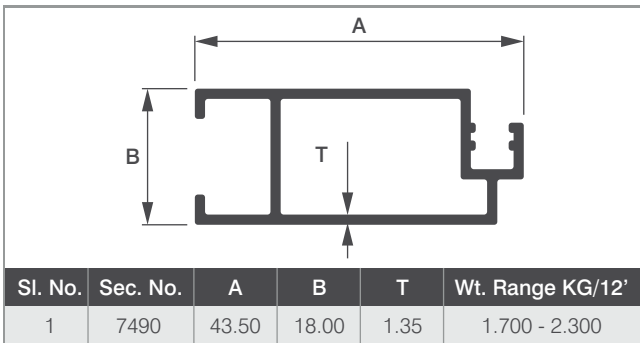
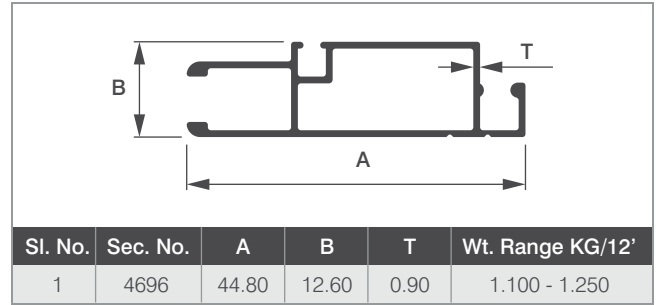
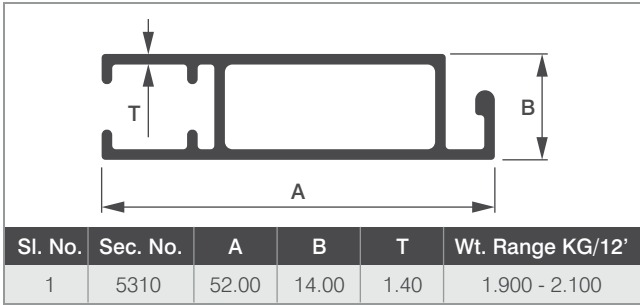



MESH SECTIONS



Sl. No.	Sec. No.	A	B	T	Wt. Range KG/12'
1	4589	35.00	8.53	1.05	1.125 - 1.325

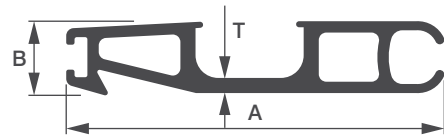

Sl. No.	Sec. No.	A	B	T	Wt. Range KG/12'
1	4753	50.00	9.80	2.00	1.800 - 1.950

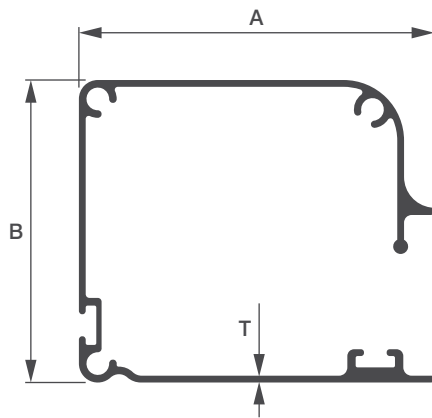

Sl. No.	Sec. No.	A	B	T	Wt. Range KG/12'
1	4590	47.00	40.00	0.90	1.725 - 2.000

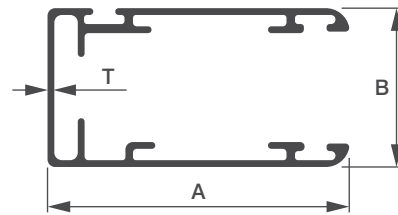

Sl. No.	Sec. No.	A	B	T	Wt. Range KG/12'
1	4592	39.90	21.00	0.90	1.300 - 1.500

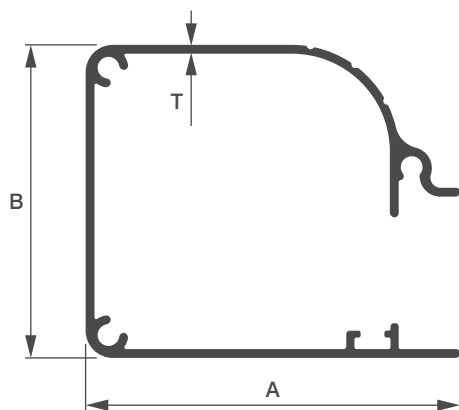

Sl. No.	Sec. No.	A	B	T	Wt. Range KG/12'
1	4715	55.00	46.00	1.30	2.450 - 2.650

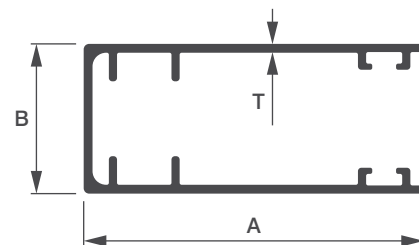

Sl. No.	Sec. No.	A	B	T	Wt. Range KG/12'
1	4716	50.00	22.00	1.30	1.850 - 2.000



MESH SECTIONS

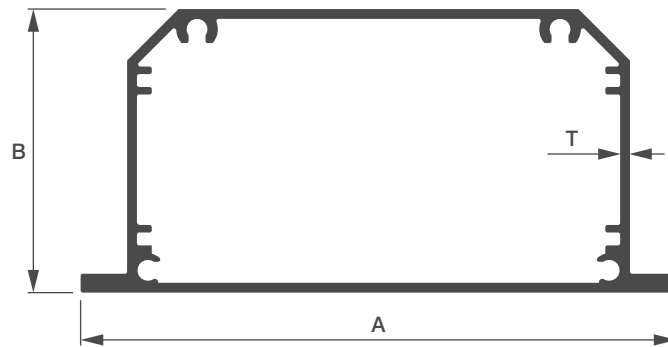

Sl. No.	Sec. No.	A	B	T	Wt. Range KG/12'
1	4720	78.80	37.50	1.30	3.200 - 3.500

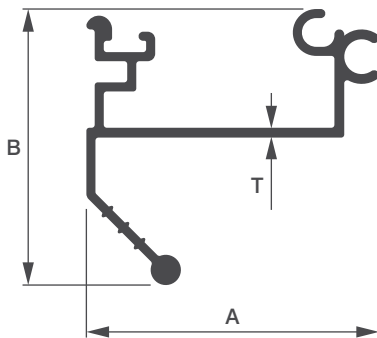

Sl. No.	Sec. No.	A	B	T	Wt. Range KG/12'
1	4721	38.70	36.50	1.30	1.600 - 1.750

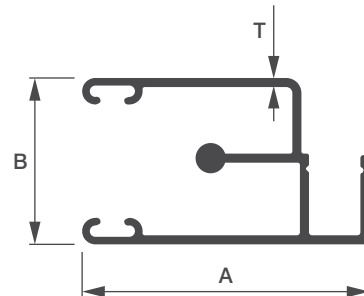

Sl. No.	Sec. No.	A	B	T	Wt. Range KG/12'
1	4722	38.00	22.00	1.20	1.450 - 1.600

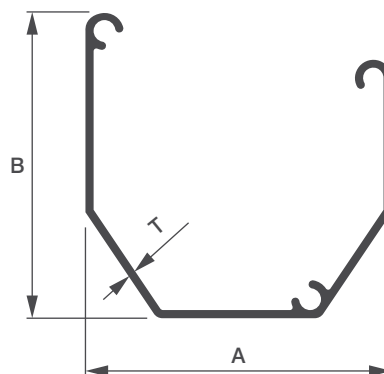

Sl. No.	Sec. No.	A	B	T	Wt. Range KG/12'
1	4724	45.00	45.00	1.20	1.500 - 1.650