

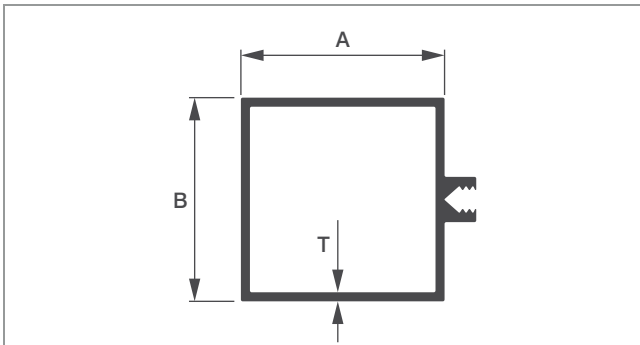

CURTAIN WALLS

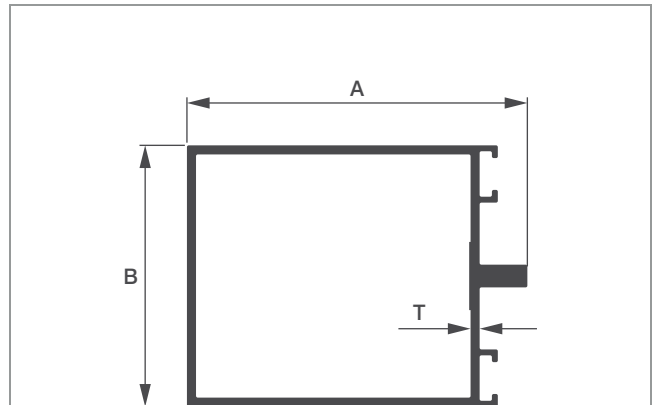

Sl. No.	Sec. No.	A	B	T	Wt. Range KG/12'
1	1651/L	45.00	45.00	1.40	2.800 - 3.200
2	1651	45.00	45.00	1.65	3.600 - 4.000
3	1651/H	45.00	45.00	2.40	5.200 - 5.600
4	1658	63.00	63.00	2.00	5.900 - 6.400



Sl. No.	Sec. No.	A	B	T	Wt. Range KG/12'
1	1652	74.90	57.60	1.80	5.100 - 5.550

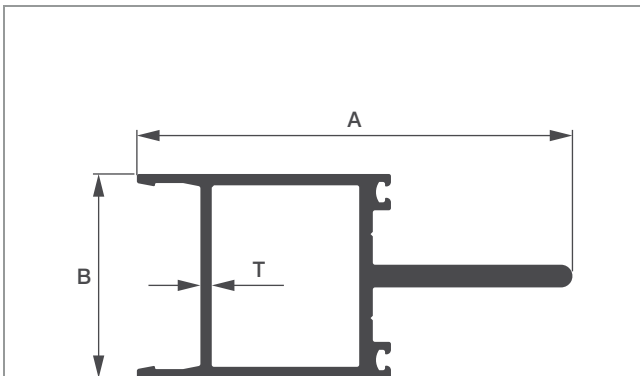

Sl. No.	Sec. No.	A	B	T	Wt. Range KG/12'
1	4107	96.00	45.00	2.40	7.000 - 7.800

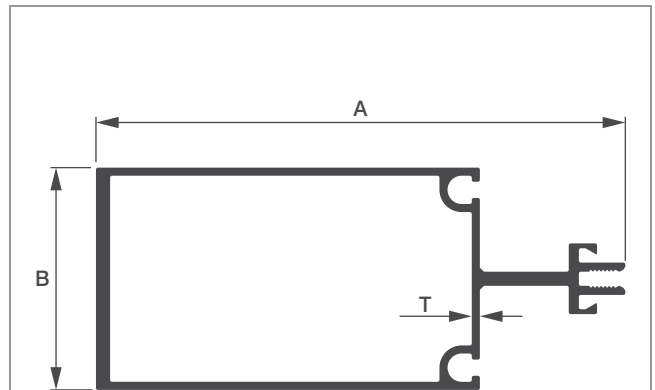

Sl. No.	Sec. No.	A	B	T	Wt. Range KG/12'
1	1653	131.00	55.00	2.00	8.750 - 9.750

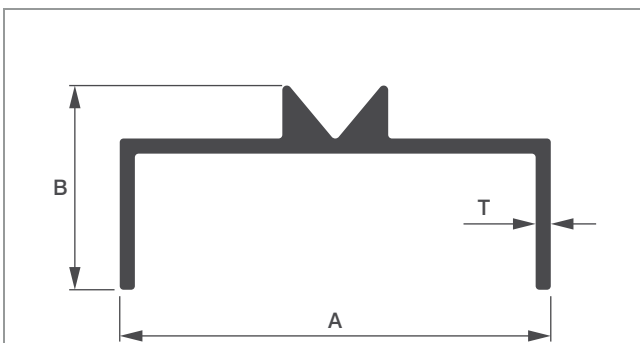

Sl. No.	Sec. No.	A	B	T	Wt. Range KG/12'
1	1697	45.00	27.00	2.00	2.100 - 2.300
2	1698	57.00	27.00	2.00	2.300 - 2.500

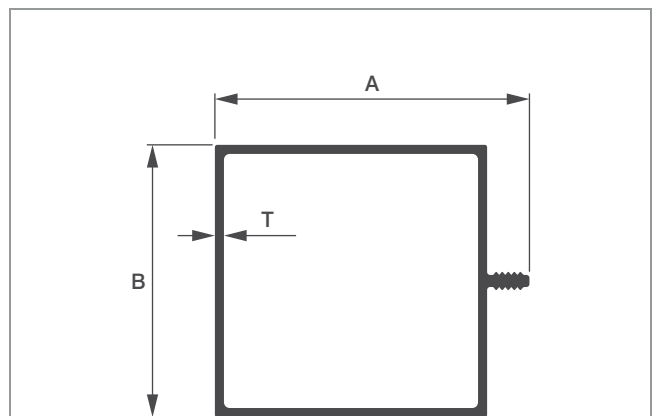

Sl. No.	Sec. No.	A	B	T	Wt. Range KG/12'
1	1659	52.00	45.00	1.50	2.750 - 3.000



CURTAIN WALLS

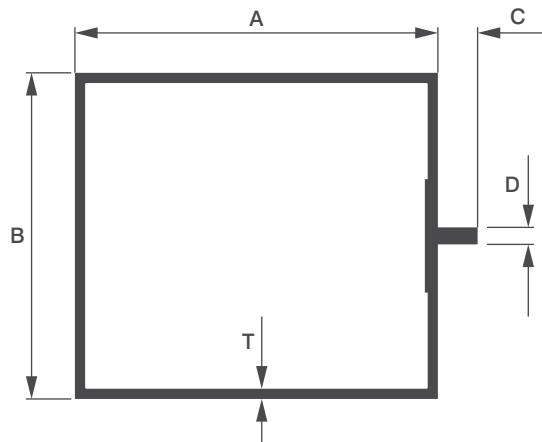

Sl. No.	Sec. No.	A	B	C	D	T	Wt. Range KG/12'
1	1654/L	64.10	57.50	10.20	5.00	1.70	4.400 - 4.800
2	1654	64.10	57.50	10.20	5.00	2.00	5.100 - 5.600
3	1654/H	64.10	57.50	10.20	5.00	2.50	6.200 - 6.800
4	1664	64.10	57.50	7.00	2.25	1.80	4.500 - 4.700
5	1678	101.70	57.50	10.20	5.00	2.00	6.770 - 7.450
6	1691	64.10	57.50	27.00	6.00	2.00	6.300 - 7.000

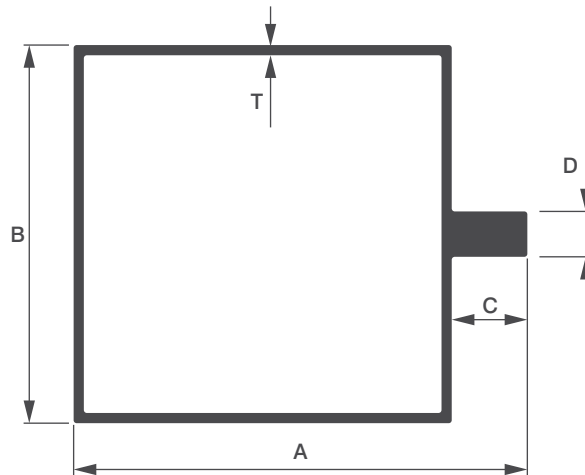

Sl. No.	Sec. No.	A	B	C	D	T	Wt. Range KG/12'
1	1771	70.00	45.00	10.00	3.00	1.50	3.300 - 3.600
2	1772	40.00	45.00	10.00	3.00	1.50	2.400 - 2.600
3	1773	60.00	50.00	10.00	6.00	1.35	3.100 - 3.400
4	7207	84.00	57.00	24.00	9.00	1.50	5.500 - 6.000
5	7208	84.00	57.00	7.00	9.00	1.50	4.500 - 4.900



CURTAIN WALLS

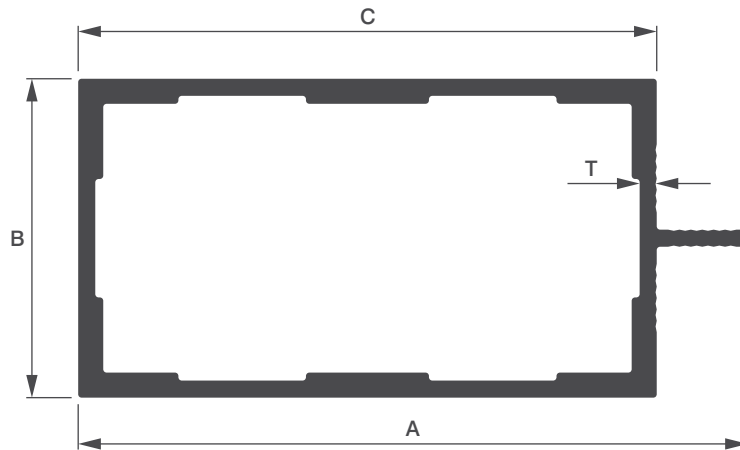

Sl. No.	Sec. No.	A	B	C	T	Wt. Range KG/12'
1	1655	58.80	28.00	50.80	1.50	2.850 - 3.200
2	1656/L	71.30	28.10	63.30	1.05	2.100 - 2.400
3	1656	71.30	28.10	63.30	1.50	3.000 - 3.400

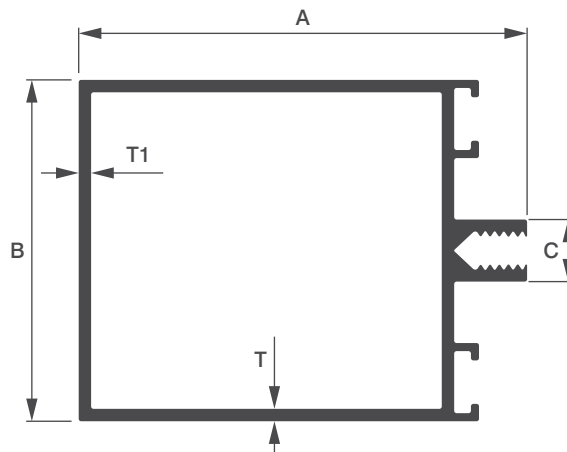

Sl. No.	Sec. No.	A	B	C	T	T1	Wt. Range KG/12'
1	1660	72.25	55.00	10.00	2.00	2.00	5.300 - 5.600
2	1666	103.70	55.00	10.00	2.00	2.00	6.500 - 7.000
3	1677	109.00	55.00	14.00	2.00	2.75	8.400 - 9.000



CURTAIN WALLS

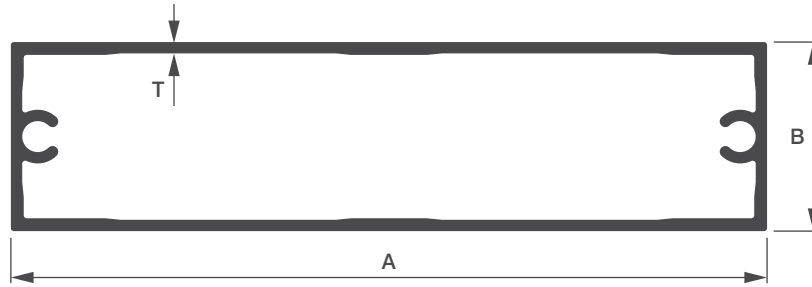

Sl. No.	Sec. No.	A	B	T	Wt. Range KG/12'
1	4630	100.00	25.00	1.50	4.050 - 4.250

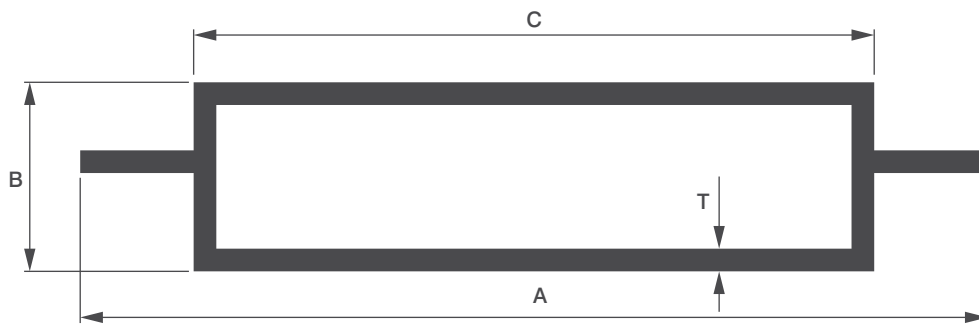

Sl. No.	Sec. No.	A	B	C	T	Wt. Range KG/12'
1	1663	120.00	25.00	90.00	3.00	7.300 - 7.600

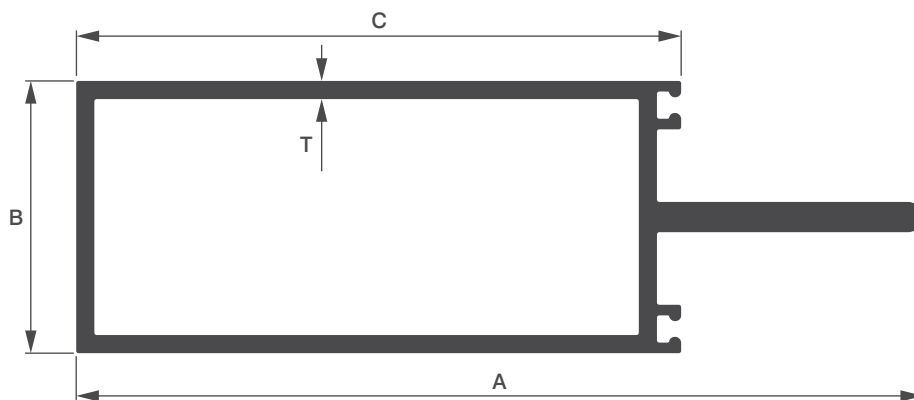

Sl. No.	Sec. No.	A	B	C	T	Wt. Range KG/12'
1	1668	90.00	45.00	50.00	2.00	5.800 - 6.300
2	1667/L	140.00	45.00	100.00	2.00	7.500 - 8.000
3	1667	140.00	45.00	100.00	3.00	10.250 - 10.750



CURTAIN WALLS

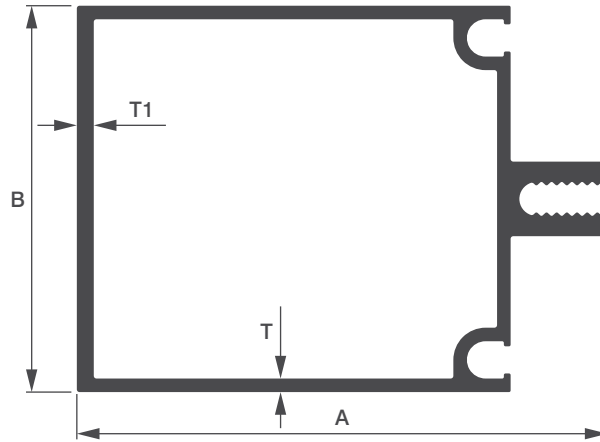

Sl. No.	Sec. No.	A	B	T	T1	Wt. Range KG/12'
1	1657	78.30	57.00	2.00	1.90	5.800 - 6.300
2	1672/L	115.90	57.00	2.00	2.50	8.100 - 8.500
3	1672	115.90	57.00	2.50	3.00	10.000 - 10.500
4	1672/H	115.90	57.00	2.50	5.00	11.300 - 11.800
5	1676	164.30	65.00	3.00	6.00	17.200 - 17.700

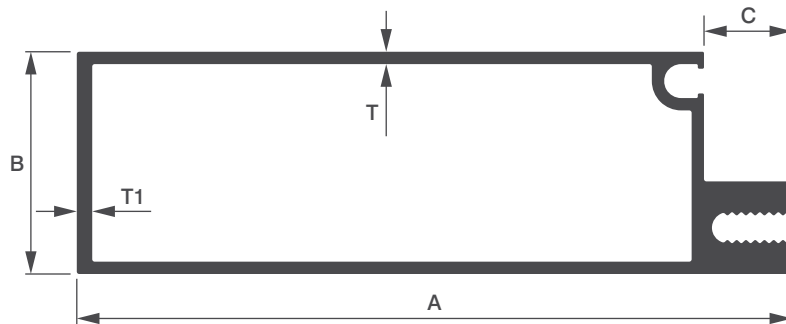

Sl. No.	Sec. No.	A	B	C	T	T1	Wt. Range KG/12'
1	1673	115.9	36.00	15.00	2.50	3.00	7.100 - 7.600
2	1674	78.30	34.00	11.00	2.00	2.50	4.800 - 5.100
3	1675	164.30	40.00	15.00	3.00	6.00	14.300 - 14.800

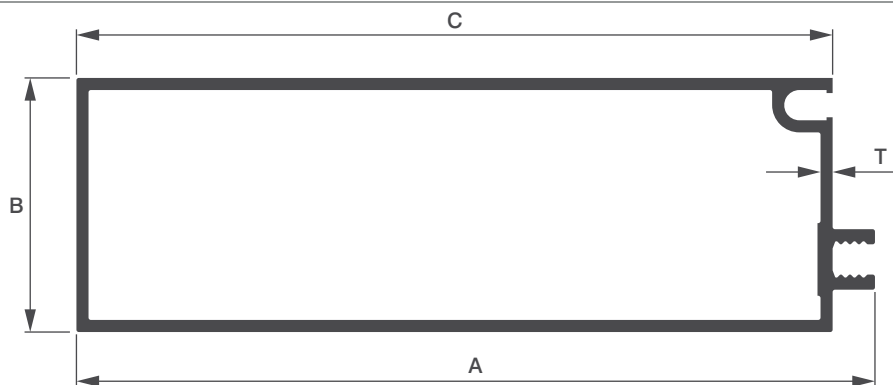

Sl. No.	Sec. No.	A	B	C	T	Wt. Range KG/12'
1	7311	132.00	42.00	125.00	2.00	6.900 - 7.300



CURTAIN WALLS

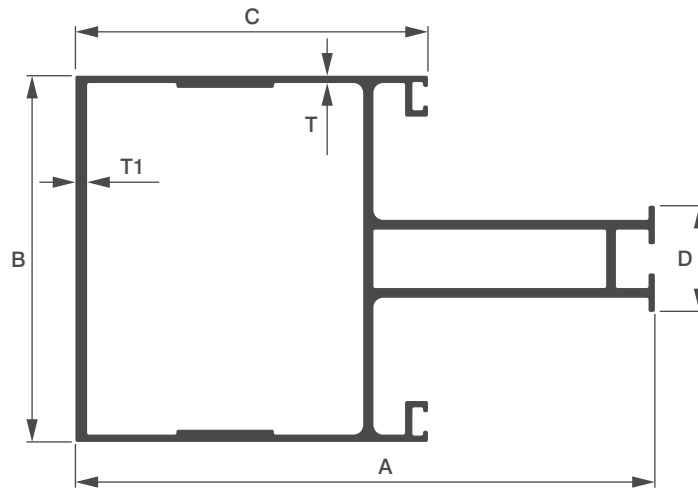

Sl. No.	Sec. No.	A	B	C	D	T	T1	Wt. Range KG/12'
1	1679	119.00	75.20	72.40	21.80	1.50	2.40	8.750 - 9.350

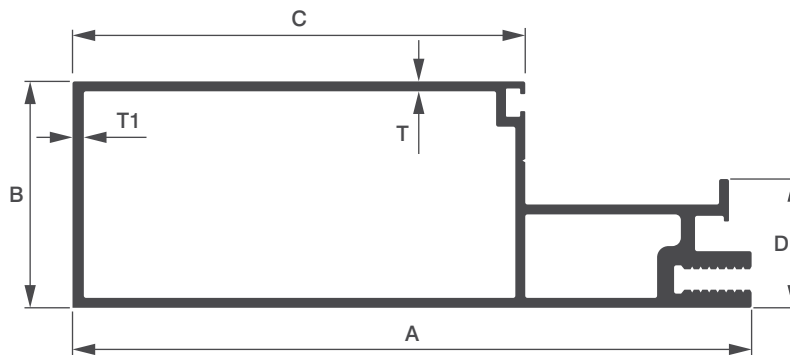

Sl. No.	Sec. No.	A	B	C	D	T	T1	Wt. Range KG/12'
1	1680	120.00	40.00	80.00	22.75	1.75	2.00	6.600 - 7.250

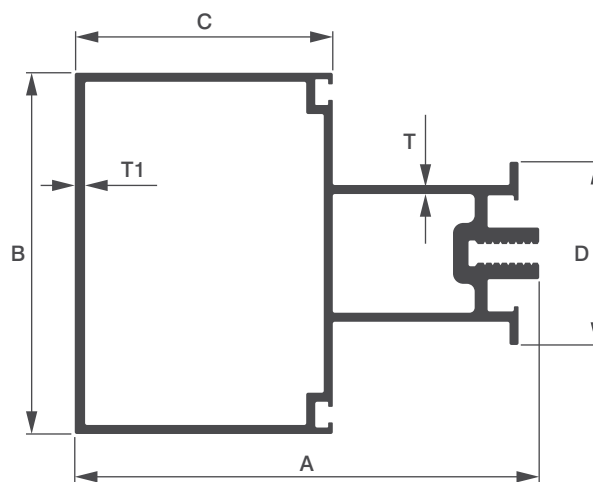

Sl. No.	Sec. No.	A	B	C	D	T	T1	Wt. Range KG/12'
1	1681	90.00	70.00	50.00	35.50	1.75	2.00	7.250 - 7.800



CURTAIN WALLS

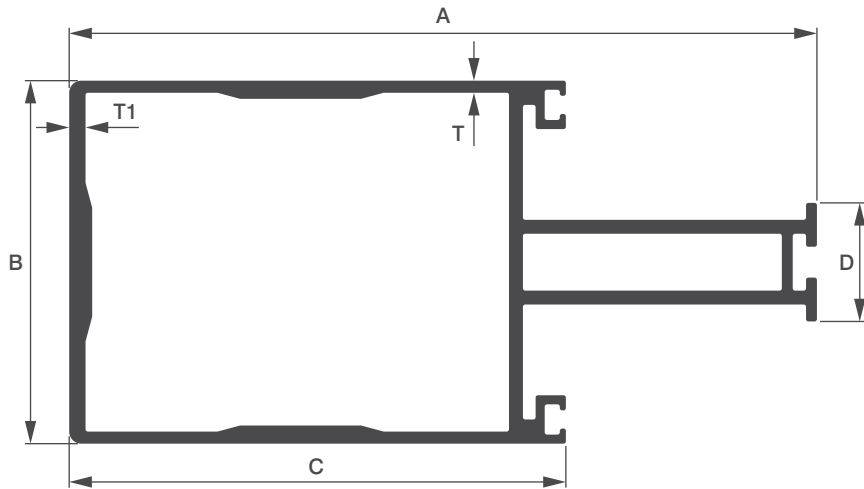

Sl. No.	Sec. No.	A	B	C	D	T	T1	Wt. Range KG/12'
1	1665	123.60	60.00	82.10	19.60	2.00	2.70	9.650 - 10.200

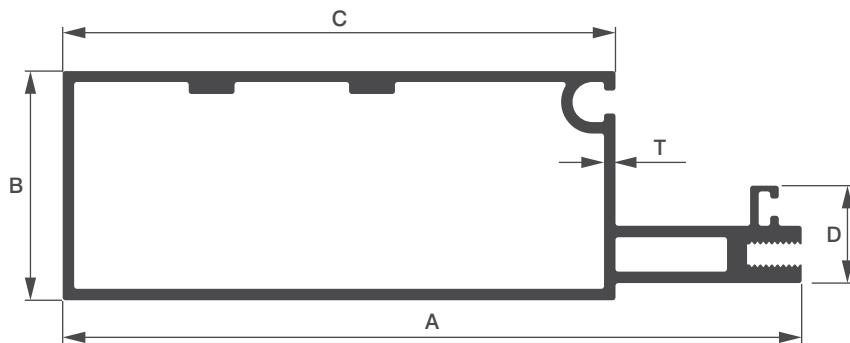

Sl. No.	Sec. No.	A	B	C	D	T	Wt. Range KG/12'
1	1688	129.00	40.00	96.50	17.00	2.00	7.500 - 8.200

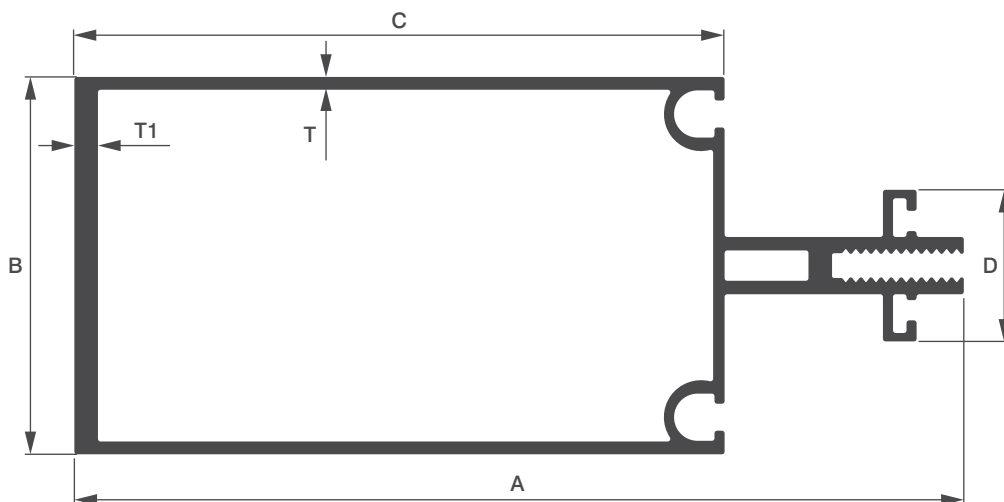

Sl. No.	Sec. No.	A	B	C	D	T	T1	Wt. Range KG/12'
1	1689	129.00	56.00	96.50	22.50	1.90	3.00	8.600 - 9.300



CURTAIN WALLS

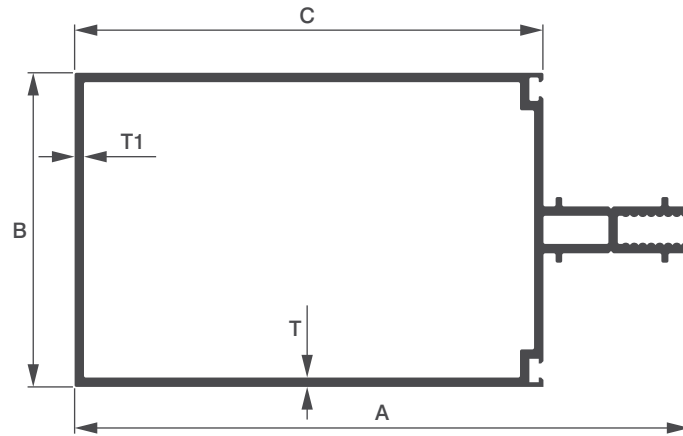

Sl. No.	Sec. No.	A	B	C	T	T1	Wt. Range KG/12'
1	1683	131.40	67.40	100.00	2.50	2.50	8.800 - 9.300
2	7716	131.16	67.00	100.00	2.00	2.00	8.000 - 8.400
3	7717	131.16	67.00	100.00	2.50	3.70	10.600 - 11.000
4	1685	81.40	67.40	50.00	2.00	2.50	6.200 - 6.600
5	1690	56.16	67.00	25.00	2.00	2.00	5.200 - 5.600
6	7287	181.16	67.00	150.00	3.00	5.00	15.200 - 15.800
7	7288	166.16	67.00	135.00	2.50	5.00	12.800 - 13.400
8	7701	151.16	67.00	120.00	3.00	3.00	11.700 - 12.300
9	7713	96.16	67.00	65.00	2.00	2.00	6.700 - 7.200

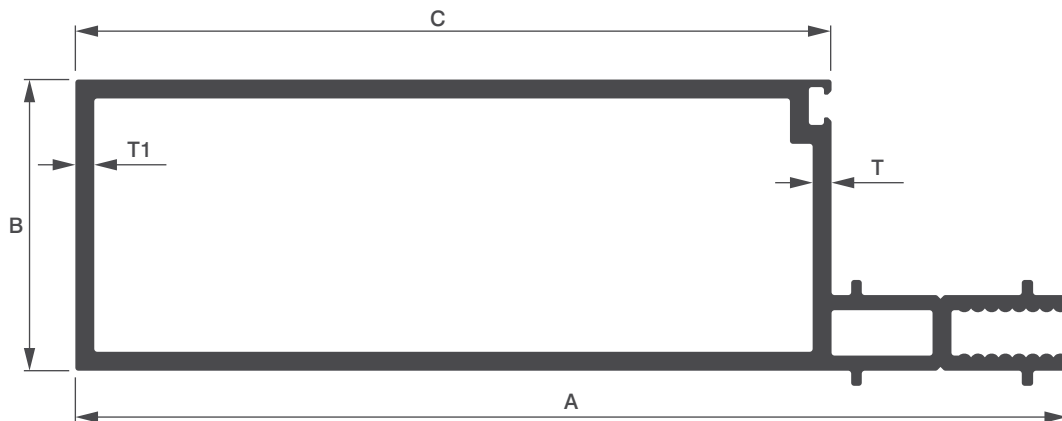

Sl. No.	Sec. No.	A	B	C	T	T1	Wt. Range KG/12'
1	1684	131.40	38.80	100.00	2.00	2.60	7.100 - 7.500
2	7718	131.16	38.50	100.00	2.50	2.50	8.100 - 8.500
3	7719	131.16	38.50	100.00	2.00	2.00	6.800 - 7.200
4	1686	81.16	38.50	50.00	2.00	2.00	5.000 - 5.300
5	7702	151.16	38.50	120.00	3.00	2.50	10.200 - 10.900
6	7703	56.16	38.50	25.00	2.00	2.00	3.900 - 4.300
7	7704	181.16	38.50	150.00	3.00	5.00	14.600 - 15.100
8	7705	167.00	38.50	135.60	2.50	5.00	10.750 - 11.350



CURTAIN WALLS

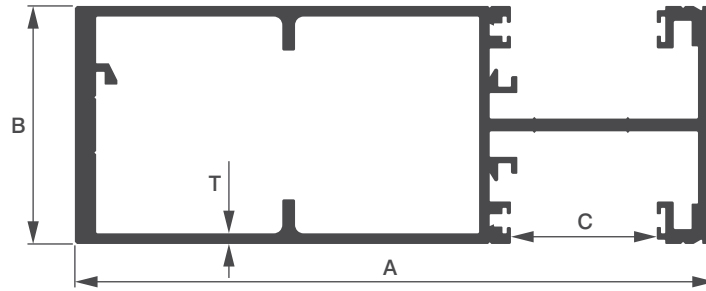

Sl. No.	Sec. No.	A	B	C	T	Wt. Range KG/12'
1	7002	150.60	56.00	34.30	2.50	15.000 - 15.500

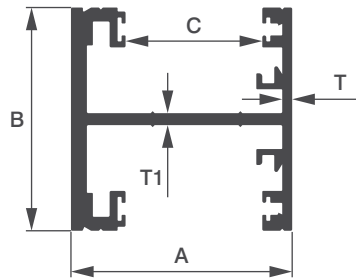

Sl. No.	Sec. No.	A	B	C	T	T1	Wt. Range KG/12'
1	7003	55.50	56.00	34.30	2.50	3.00	7.200 - 7.800

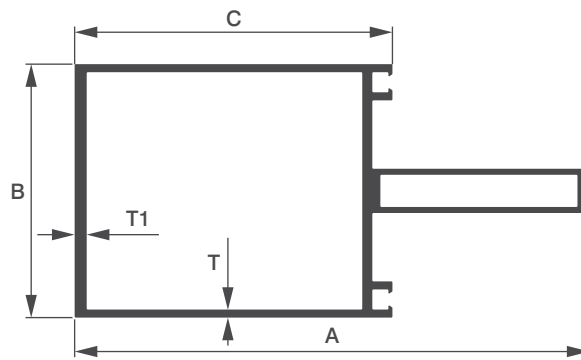

Sl. No.	Sec. No.	A	B	C	T	T1	Wt. Range KG/12'
1	7005	128.00	63.00	79.00	2.00	3.00	8.550 - 8.750

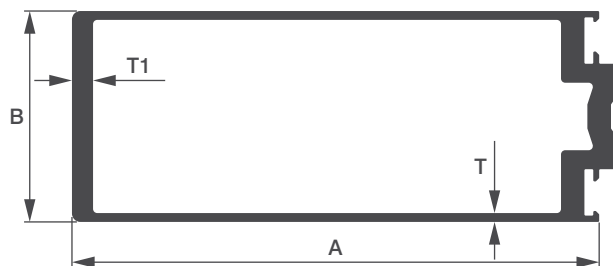

Sl. No.	Sec. No.	A	B	T	T1	Wt. Range KG/12'
1	7006	125.00	50.00	2.10	5.00	10.900 - 11.200



CURTAIN WALLS

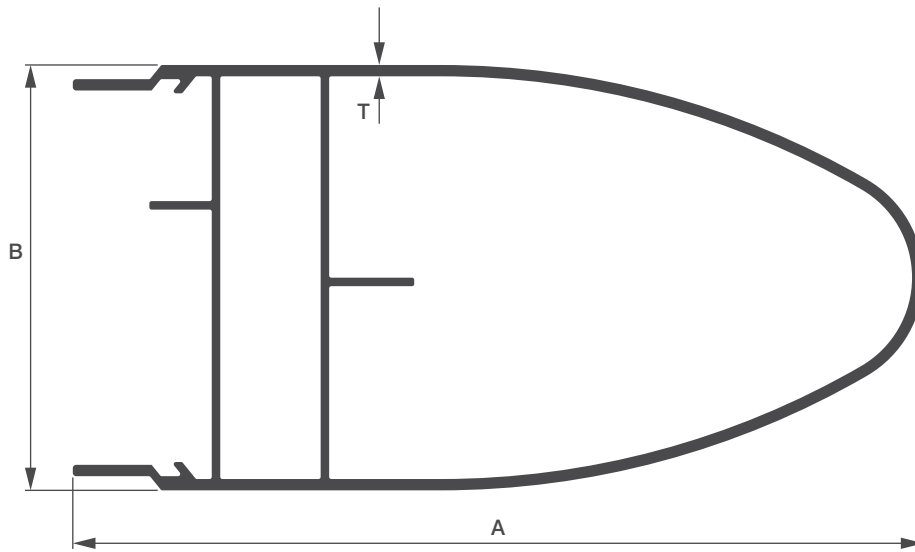

Sl. No.	Sec. No.	A	B	T	Wt. Range KG/12'
1	7007	150.00	75.00	2.00	9.000 - 9.500

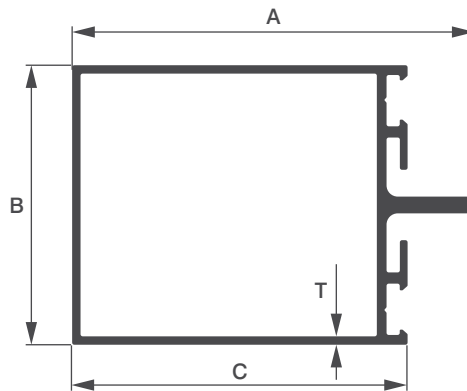

Sl. No.	Sec. No.	A	B	C	T	Wt. Range KG/12'
1	7008	72.00	50.00	60.00	1.50	4.100 - 4.400

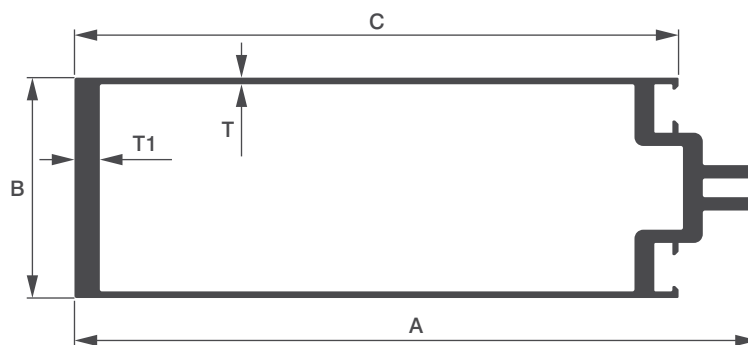

Sl. No.	Sec. No.	A	B	C	T	T1	Wt. Range KG/12'
1	7009	155.07	50.00	137.07	1.50	5.75	10.300 - 11.000



CURTAIN WALLS

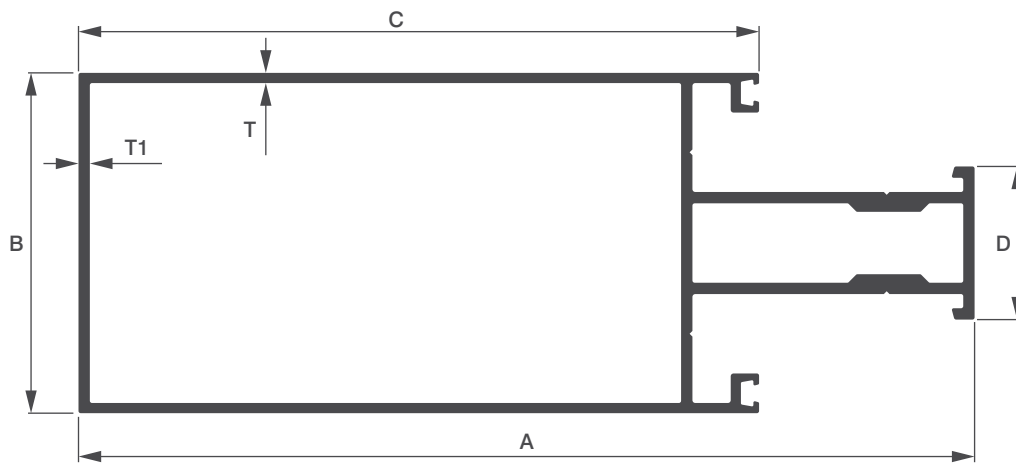

Sl. No.	Sec. No.	A	B	C	D	T	T1	Wt. Range KG/12'
1	7013	158.00	60.00	120.00	27.00	1.80	2.00	9.600 - 10.300

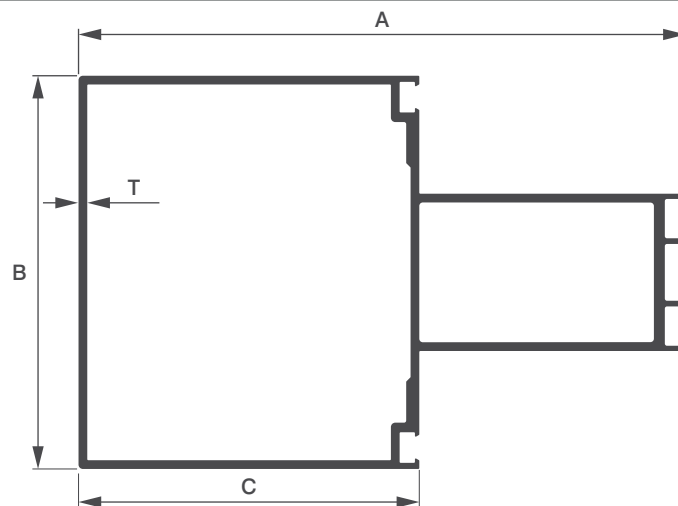

Sl. No.	Sec. No.	A	B	C	T	Wt. Range KG/12'
1	7014	139.00	90.00	78.00	2.00	10.250 - 11.000

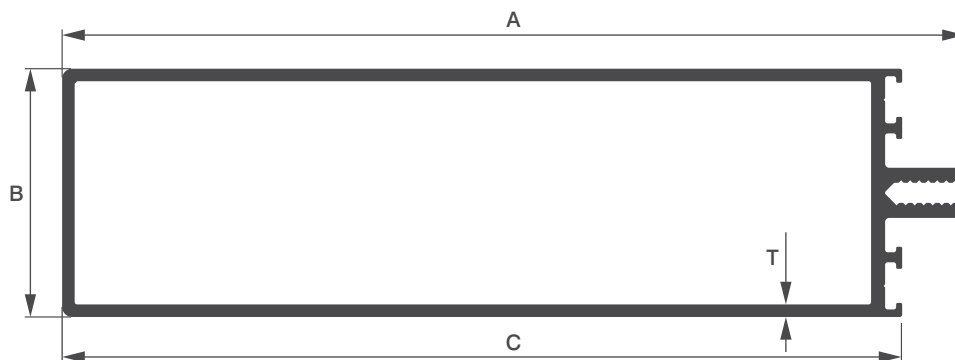

Sl. No.	Sec. No.	A	B	C	T	Wt. Range KG/12'
1	7015	180.00	49.50	167.50	2.50	11.100 - 11.700



CURTAIN WALLS

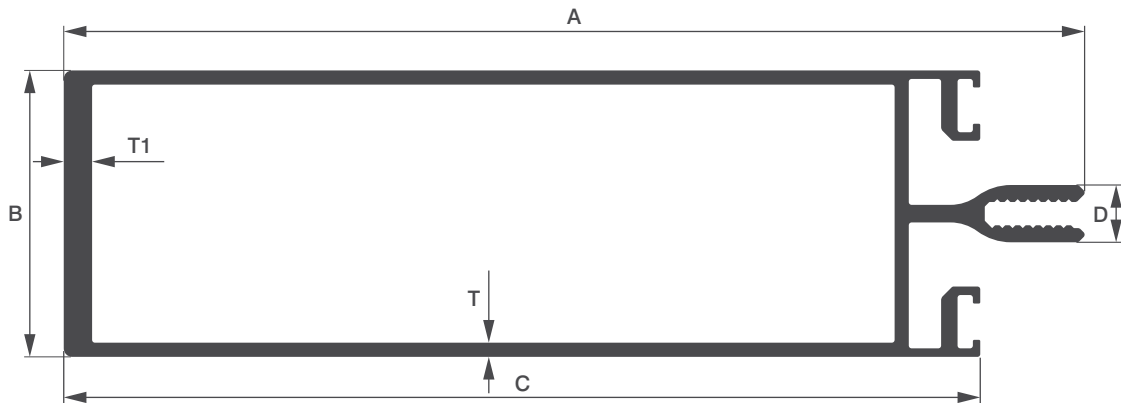

Sl. No.	Sec. No.	A	B	C	D	T	T1	Wt. Range KG/12'
1	7016	180.00	50.50	161.60	10.00	2.50	5.00	13.100 - 13.700
2	7016/R	180.00	50.50	161.60	10.00	2.50	2.50	12.000 - 12.500

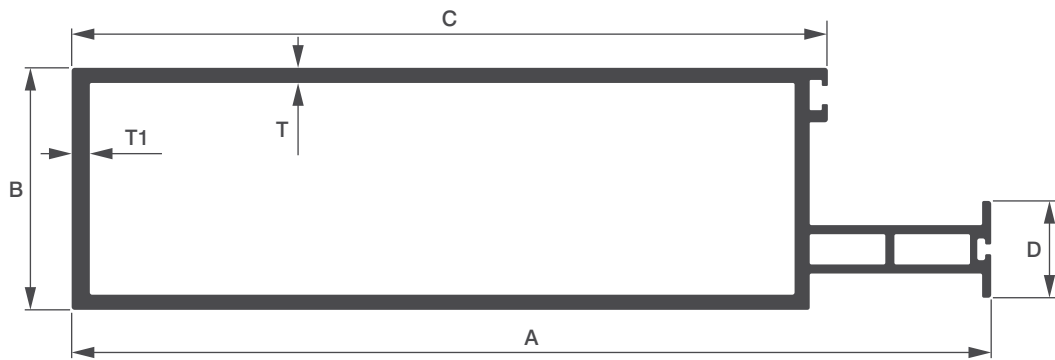

Sl. No.	Sec. No.	A	B	C	D	T	T1	Wt. Range KG/12'
1	7017	152.00	40.00	125.00	12.80	2.50	3.00	9.200 - 9.800

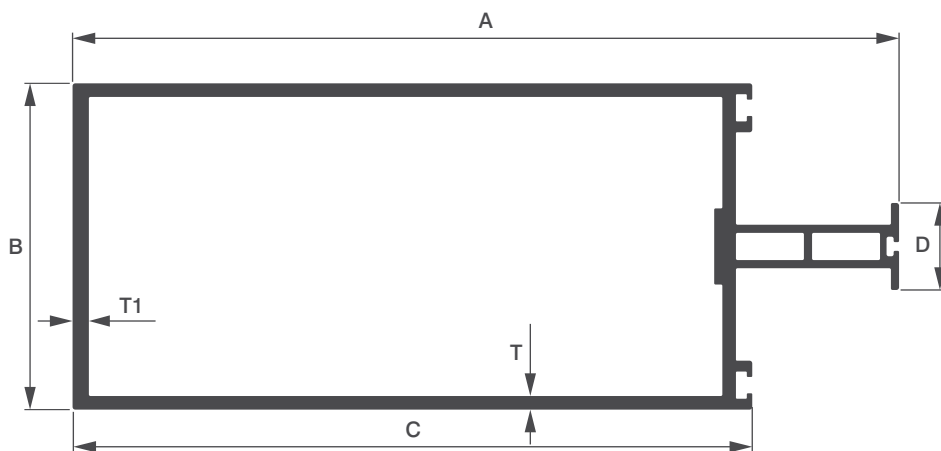

Sl. No.	Sec. No.	A	B	C	D	T	T1	Wt. Range KG/12'
1	7018	152.00	60.00	125.00	16.00	2.50	3.00	10.600 - 11.100



CURTAIN WALLS

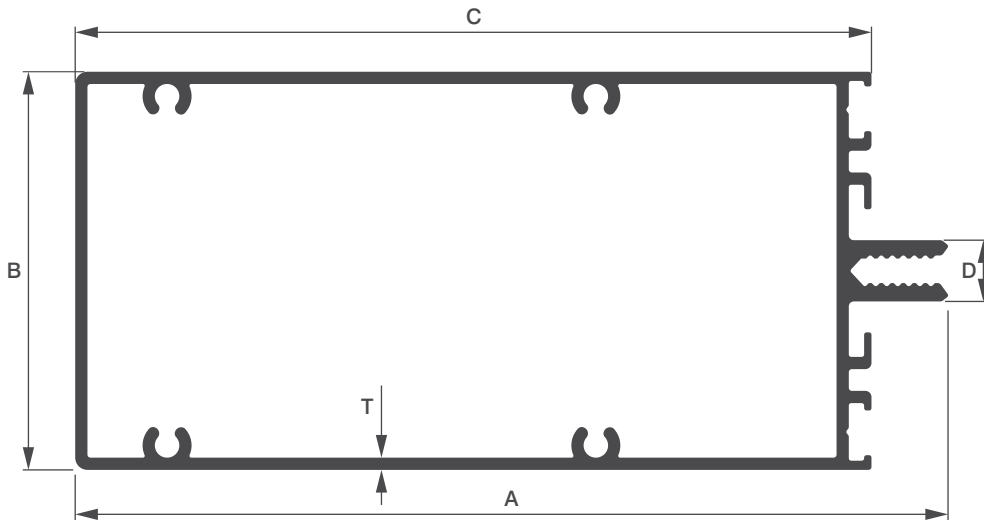

Sl. No.	Sec. No.	A	B	C	D	T	Wt. Range KG/12'
1	7031	142.50	65.00	131.30	10.10	2.00	9.900 - 10.400

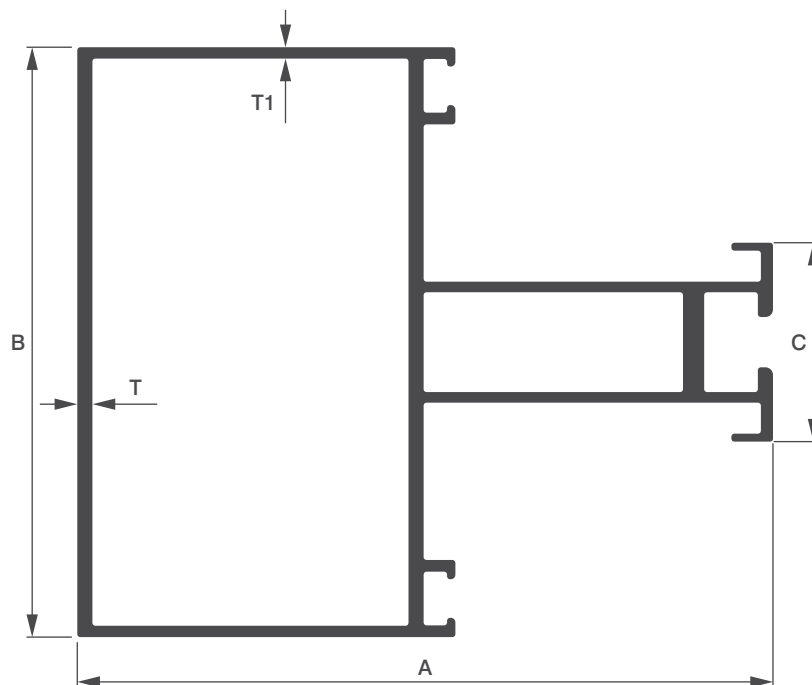

Sl. No.	Sec. No.	A	B	C	T	T1	Wt. Range KG/12'
1	7331	92.00	78.00	26.30	1.50	2.00	6.600 - 7.000
2	7332	122.00	78.00	26.30	1.50	2.00	7.400 - 8.000



CURTAIN WALLS

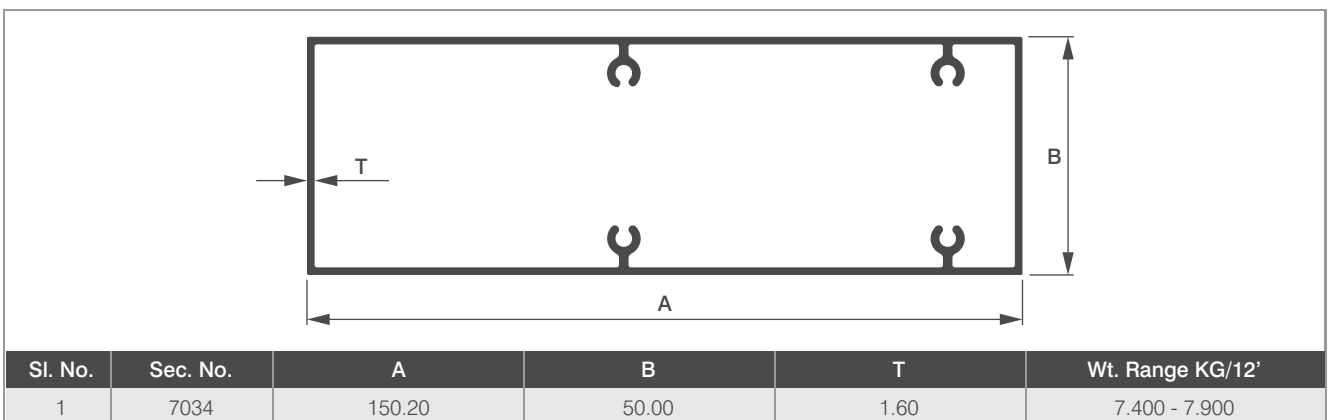
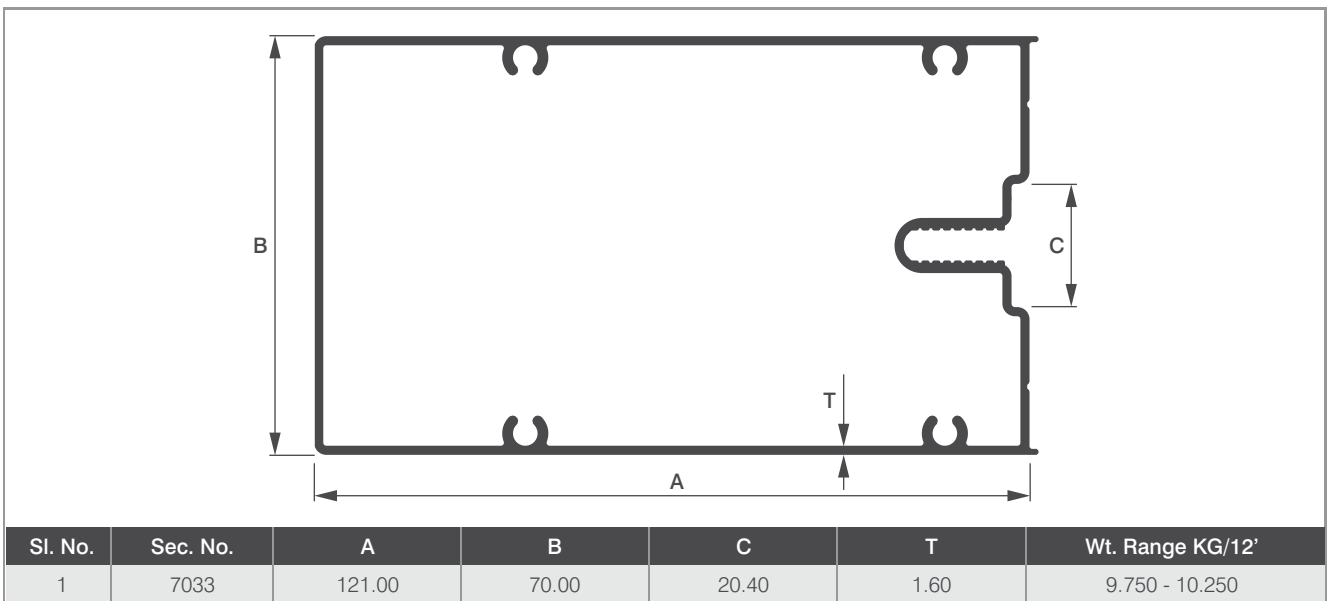
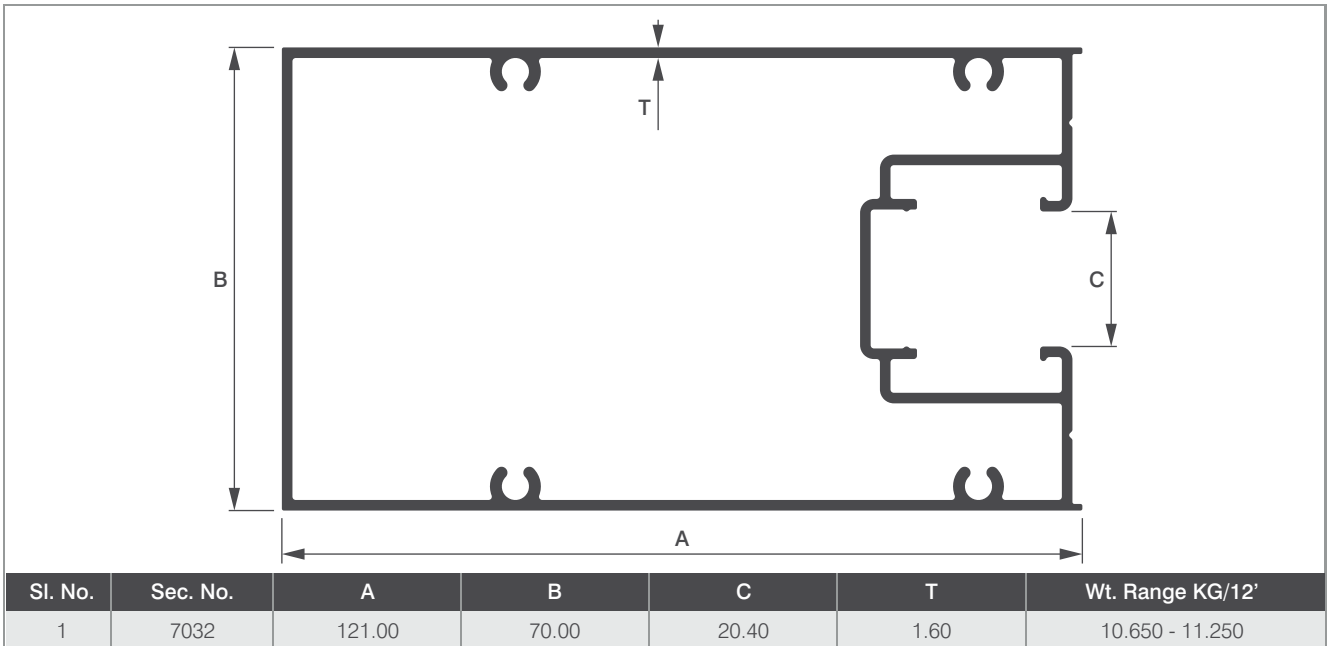



CURTAIN WALLS

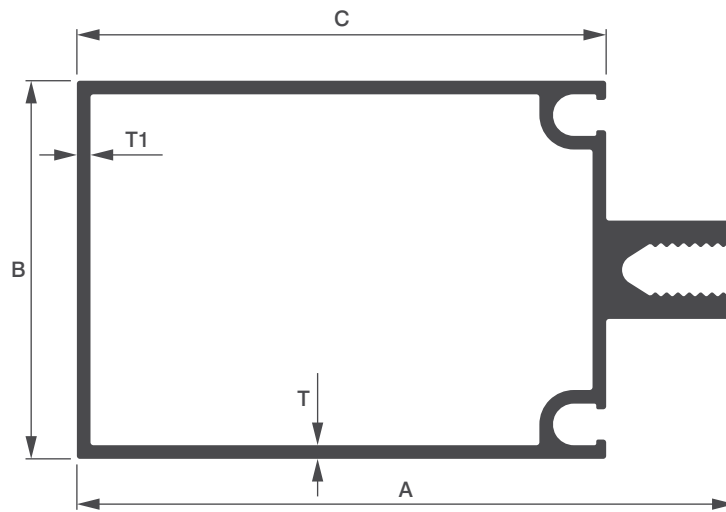

Sl. No.	Sec. No.	A	B	C	T	T1	Wt. Range KG/12'
1	7235	117.00	100.00	100.00	1.80	2.30	9.000 - 9.400
2	7236	87.00	100.00	70.00	1.80	2.30	8.000 - 8.400
3	7242	87.00	50.00	70.00	1.80	1.80	5.600 - 6.000

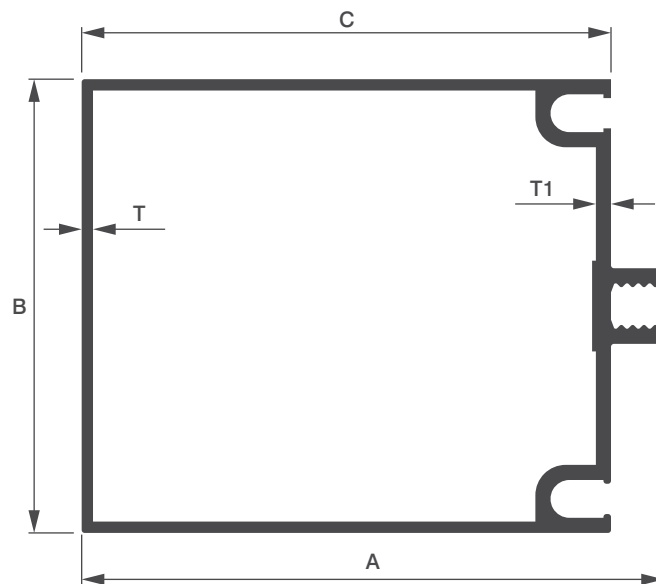

Sl. No.	Sec. No.	A	B	C	T	T1	Wt. Range KG/12'
1	7301	132.00	60.00	125.00	2.50	2.50	9.400 - 9.800
2	7309	57.00	60.00	50.00	1.50	2.00	4.200 - 4.600
3	7310	77.00	60.00	70.00	2.50	2.50	6.800 - 7.000
4	7345	77.00	60.00	70.00	1.50	1.50	4.500 - 4.900
5	7344	107.00	60.00	100.00	2.50	2.50	8.200 - 8.600
6	7348	107.00	60.00	100.00	1.80	2.50	6.550 - 6.950



CURTAIN WALLS

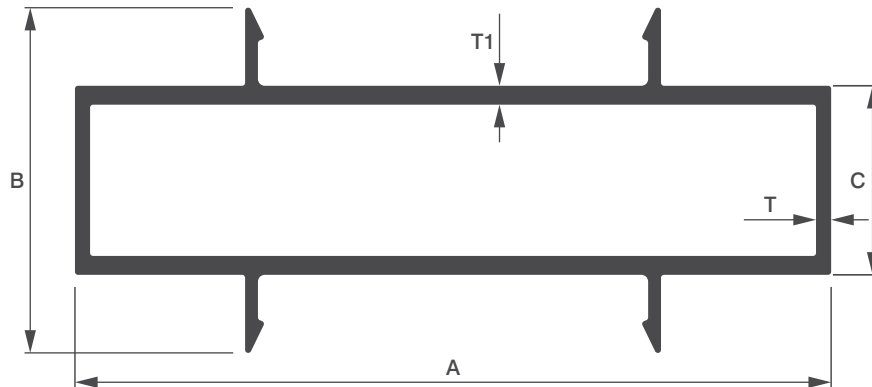

Sl. No.	Sec. No.	A	B	C	T	T1	Wt. Range KG/12'
1	7292	100.00	45.64	25.00	2.00	2.50	6.400 - 6.800

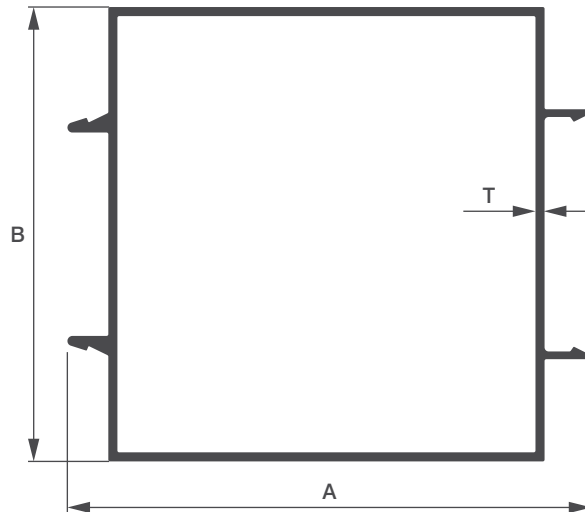

Sl. No.	Sec. No.	A	B	T	Wt. Range KG/12'
1	7293	115.35	100.00	2.00	8.400 - 8.800

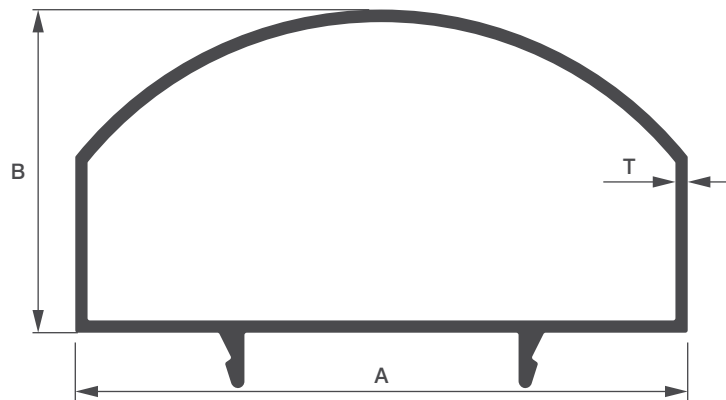

Sl. No.	Sec. No.	A	B	T	Wt. Range KG/12'
1	7294	100.00	52.74	2.00	5.800 - 6.200



CURTAIN WALLS

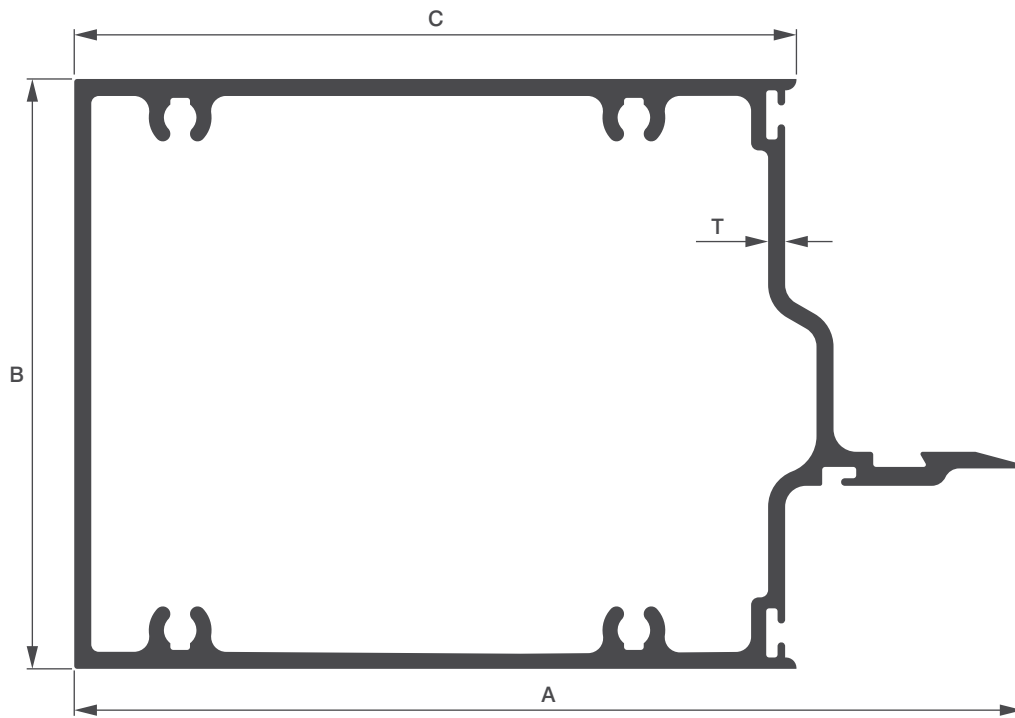

Sl. No.	Sec. No.	A	B	C	T	Wt. Range KG/12'
1	6431	125.40	78.00	95.50	2.25	9.475 - 9.650

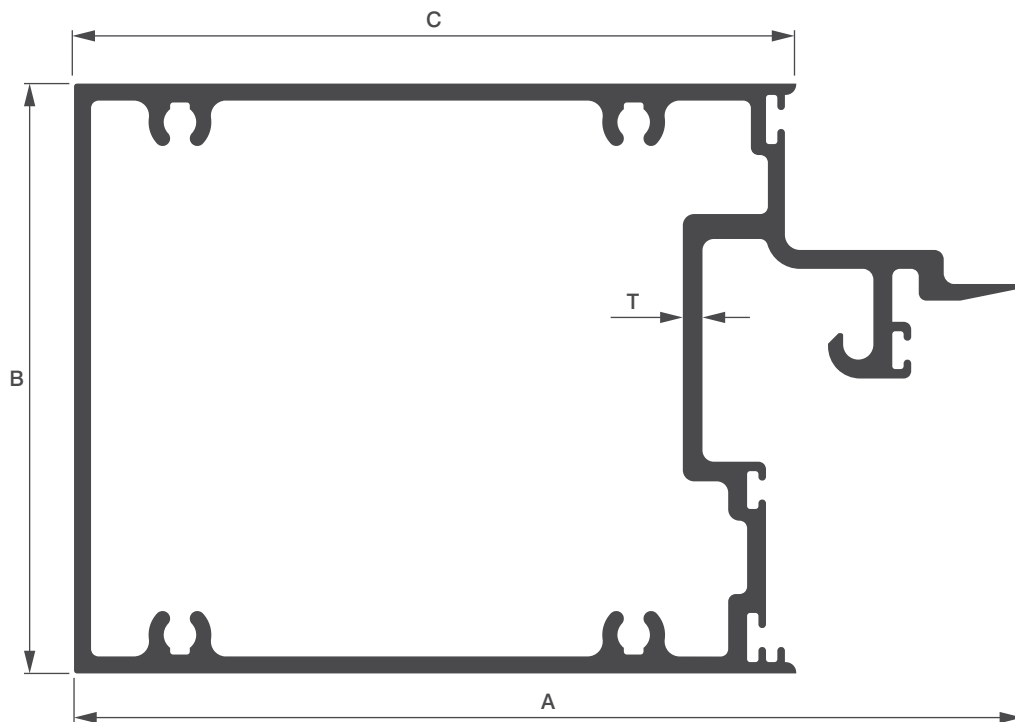

Sl. No.	Sec. No.	A	B	C	T	Wt. Range KG/12'
1	6432	125.40	78.00	95.50	2.60	11.050 - 11.250



CURTAIN WALLS

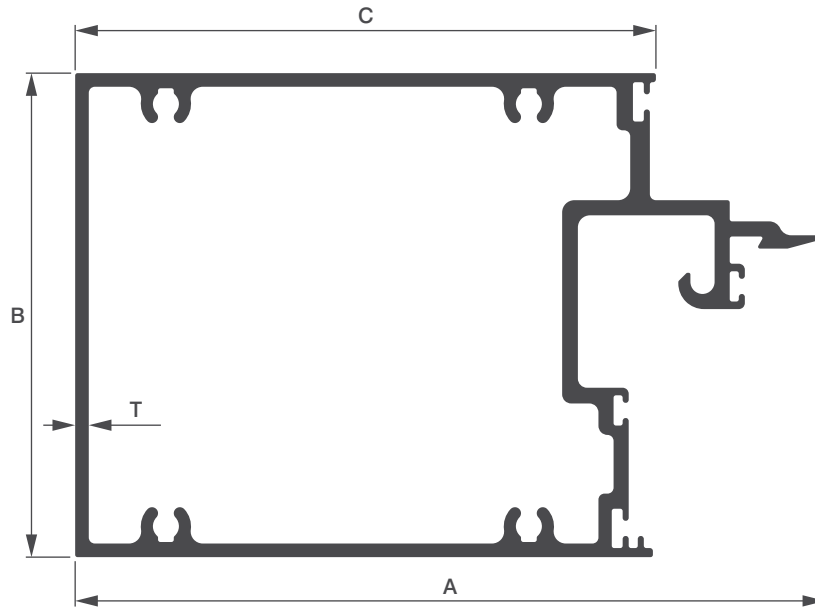

Sl. No.	Sec. No.	A	B	C	T	Wt. Range KG/12'
1	7314	124.00	80.00	96.00	2.25	11.000 - 11.500

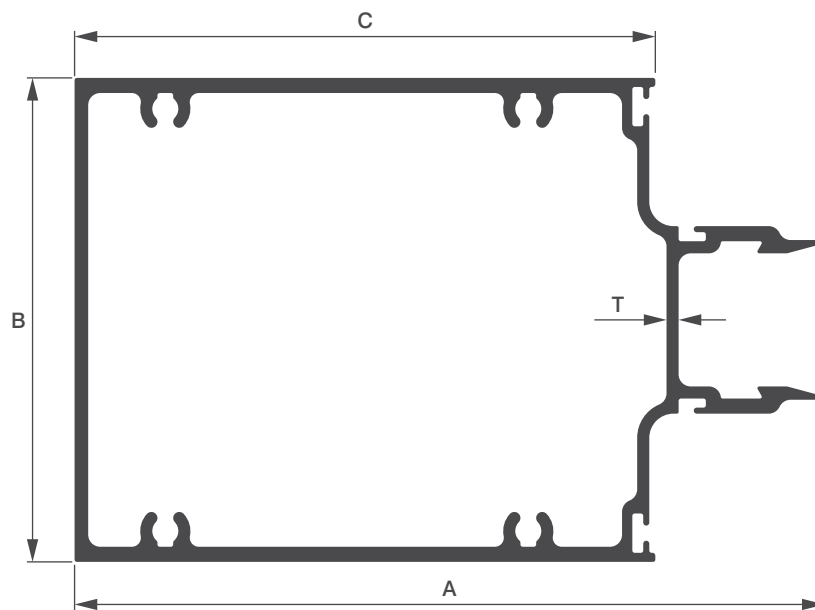

Sl. No.	Sec. No.	A	B	C	T	Wt. Range KG/12'
1	7315	124.00	80.00	96.00	2.00	10.300 - 10.800



CURTAIN WALLS

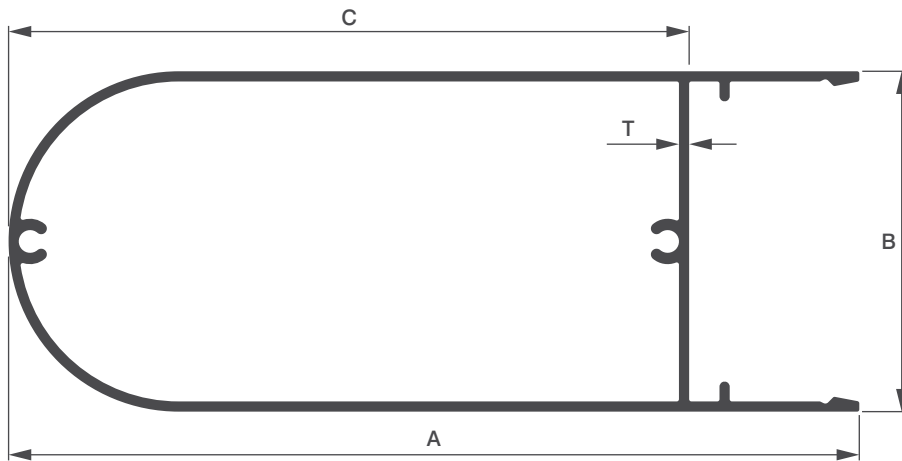

Sl. No.	Sec. No.	A	B	C	T	Wt. Range KG/12'
1	7335	150.00	60.00	120.00	1.80	7.450 - 7.950

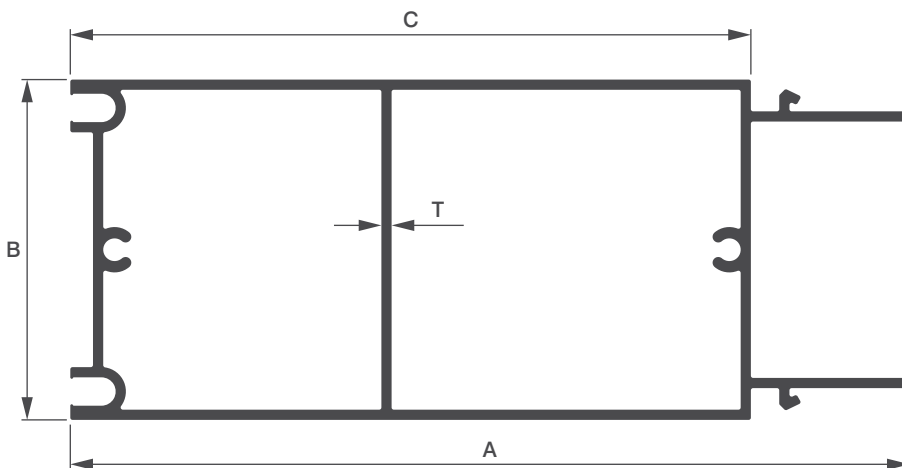

Sl. No.	Sec. No.	A	B	C	T	Wt. Range KG/12'
1	7336	148.00	60.00	120.00	1.80	9.200 - 9.800



CURTAIN WALLS

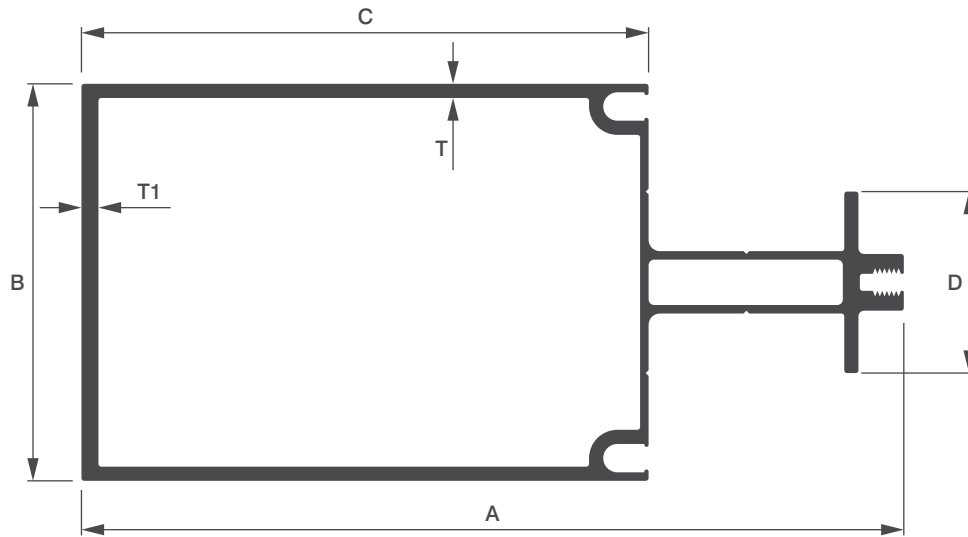

Sl. No.	Sec. No.	A	B	C	D	T	T1	Wt. Range KG/12'
1	7339	145.00	70.00	100.00	32.00	2.50	3.00	10.500 - 11.100

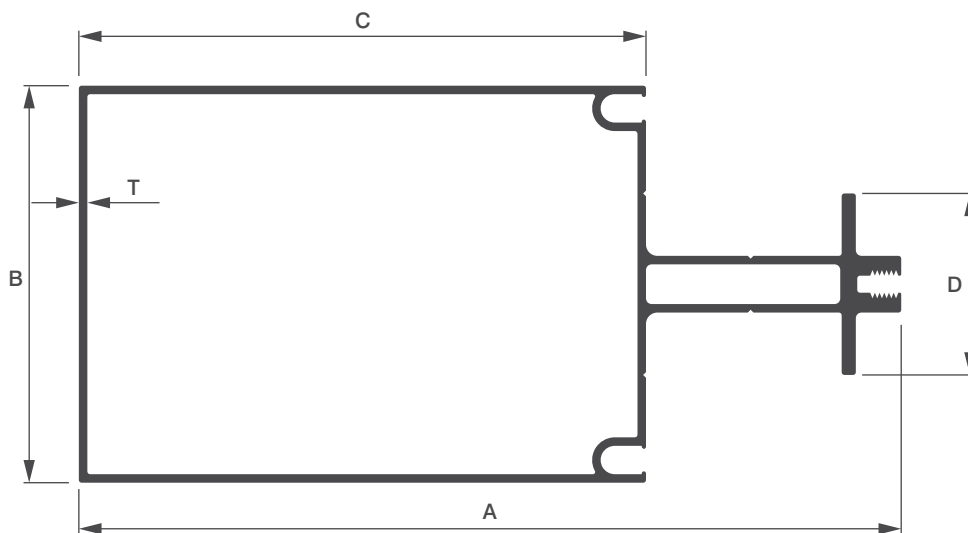

Sl. No.	Sec. No.	A	B	C	D	T	Wt. Range KG/12'
1	7340	145.00	70.00	100.00	32.00	1.50	7.500 - 8.100



CURTAIN WALLS

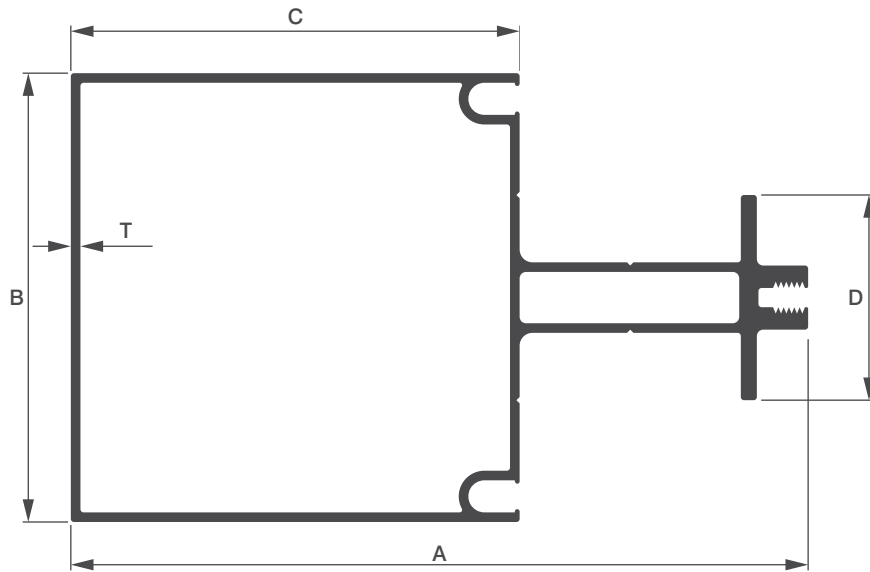

Sl. No.	Sec. No.	A	B	C	D	T	Wt. Range KG/12'
1	7341	115.00	70.00	70.00	32.00	1.50	6.600 - 7.200

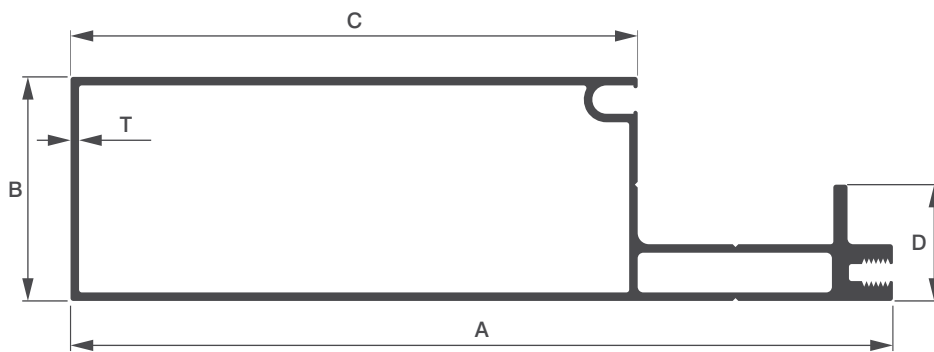

Sl. No.	Sec. No.	A	B	C	D	T	Wt. Range KG/12'
1	7342	145.00	39.50	100.00	20.50	1.50	6.200 - 6.800

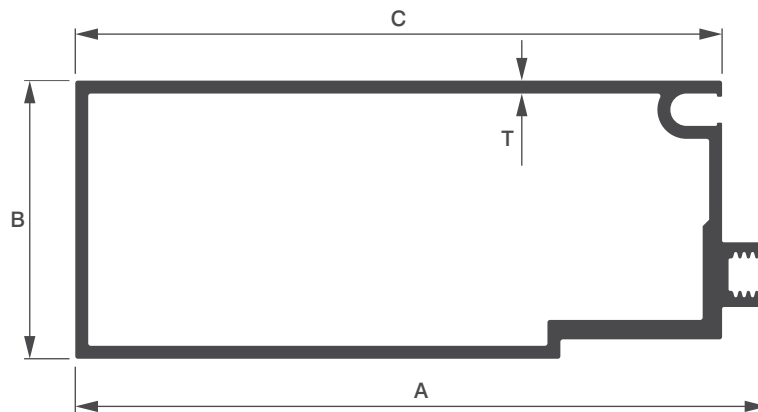

Sl. No.	Sec. No.	A	B	C	T	Wt. Range KG/12'
1	7343	107.00	43.00	100.00	2.00	6.350 - 6.850



CURTAIN WALLS

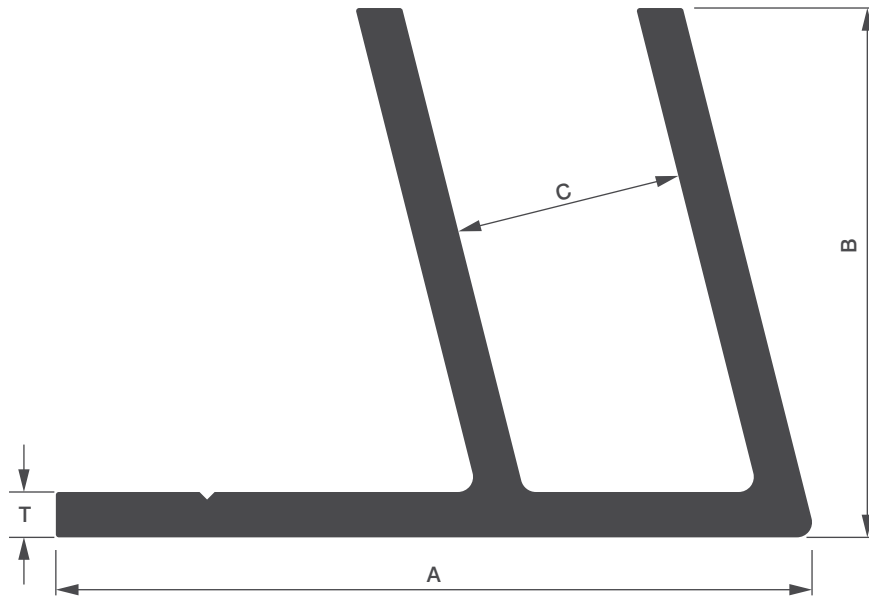

Sl. No.	Sec. No.	A	B	C	T	Wt. Range KG/12'
1	7346	100.00	70.00	30.00	6.00	13.700 - 14.150

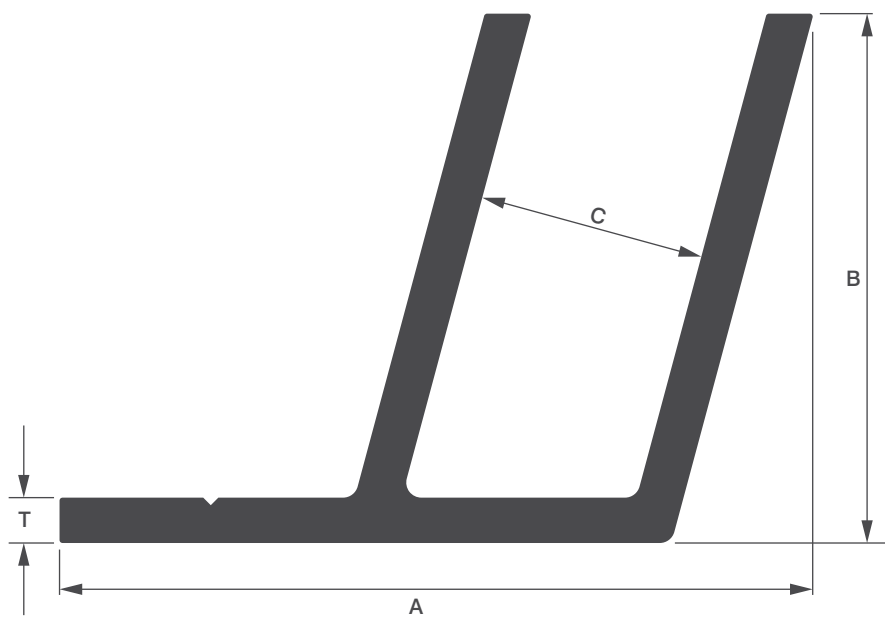

Sl. No.	Sec. No.	A	B	C	T	Wt. Range KG/12'
1	7347	99.60	70.00	30.00	6.00	12.700 - 13.100



CURTAIN WALLS

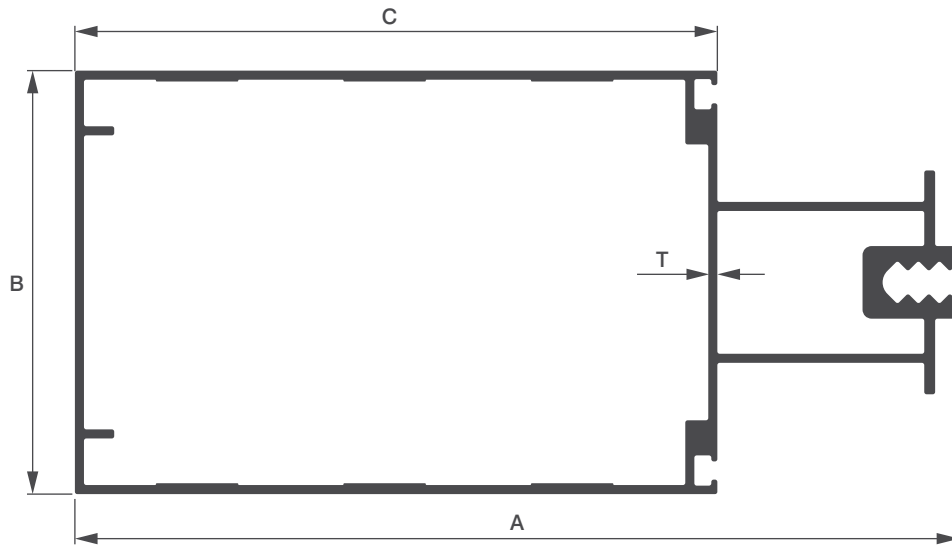

Sl. No.	Sec. No.	A	B	C	T	Wt. Range KG/12'
1	7451	146.20	70.00	106.20	1.50	8.600 - 9.000

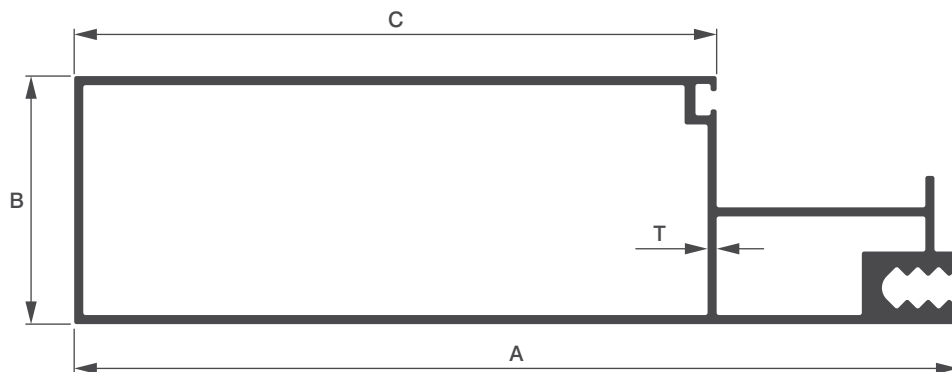

Sl. No.	Sec. No.	A	B	C	T	Wt. Range KG/12'
1	7452	146.20	41.00	106.20	1.50	6.600 - 7.000

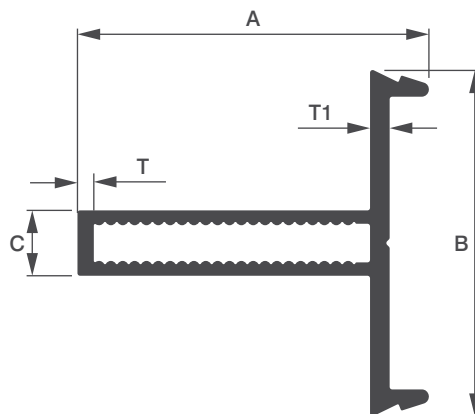

Sl. No.	Sec. No.	A	B	C	T	T1	Wt. Range KG/12'
1	7291	53.75	52.85	10.00	2.50	3.00	3.800 - 4.100



CURTAIN WALLS

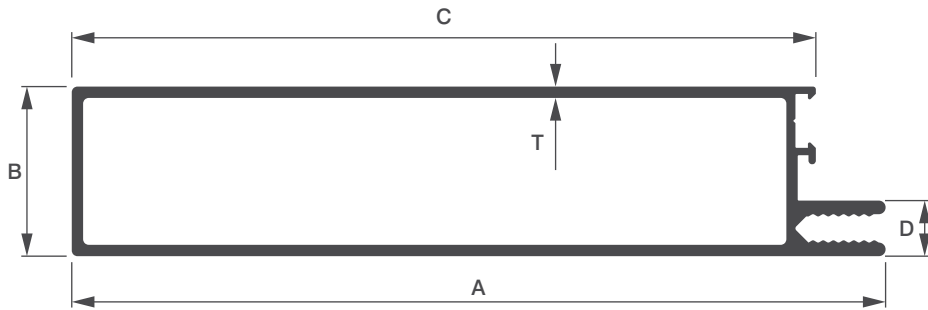

Sl. No.	Sec. No.	A	B	C	D	T	Wt. Range KG/12'
1	7715	143.50	29.90	131.20	9.80	2.00	6.950 - 7.500

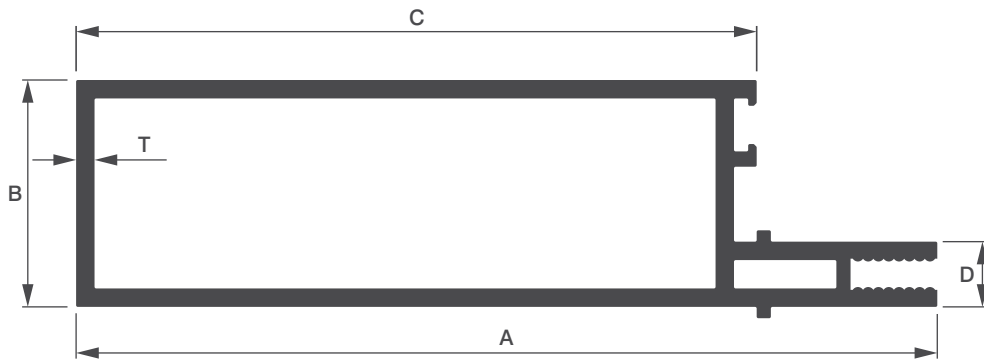

Sl. No.	Sec. No.	A	B	C	D	T	Wt. Range KG/12'
1	7709	151.84	40.00	120.00	11.50	3.25	12.400 - 12.950

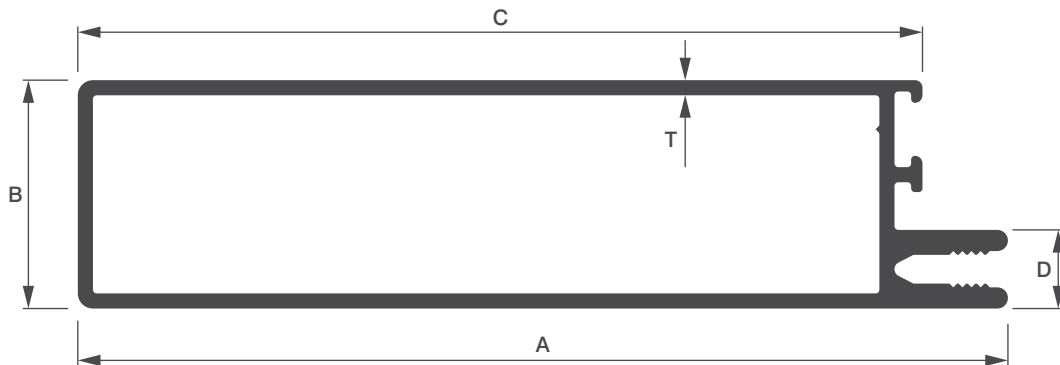

Sl. No.	Sec. No.	A	B	C	D	T	Wt. Range KG/12'
1	7714	123.00	30.20	111.70	10.40	2.00	6.400 - 6.800



CURTAIN WALLS

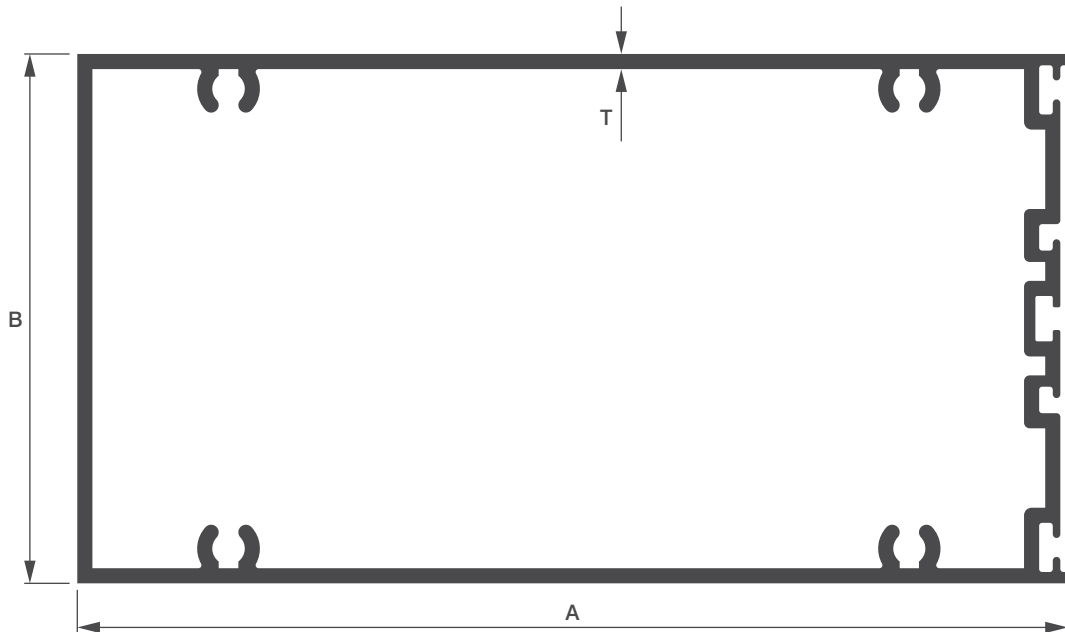

Sl. No.	Sec. No.	A	B	T	Wt. Range KG/12'
1	8009	131.00	70.00	2.00	9.200 - 9.800

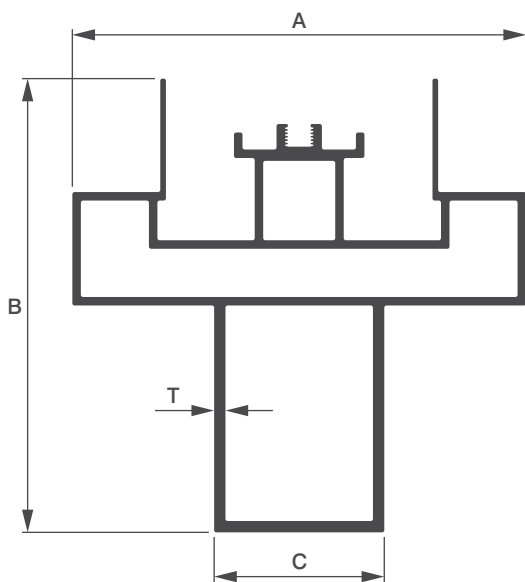

Sl. No.	Sec. No.	A	B	C	T	Wt. Range KG/12'
1	8010	80.00	80.00	30.00	2.00	6.700 - 7.100

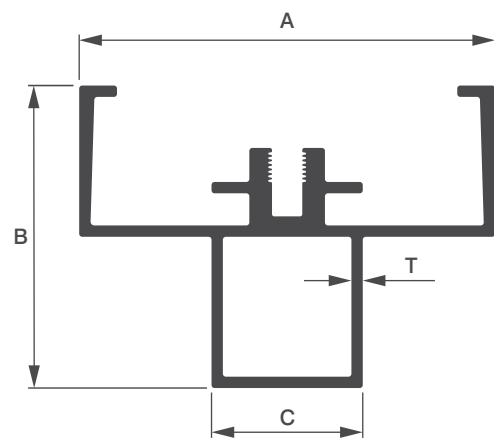

Sl. No.	Sec. No.	A	B	C	T	Wt. Range KG/12'
1	8011	55.00	40.00	20.00	1.50	3.100 - 3.400



CURTAIN WALLS

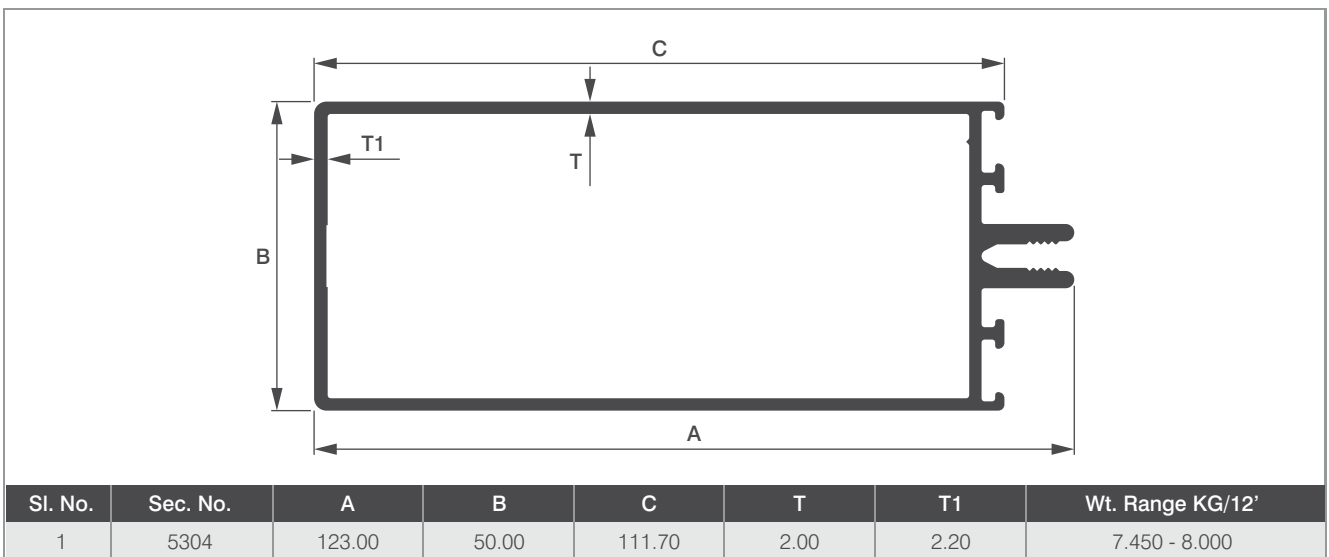
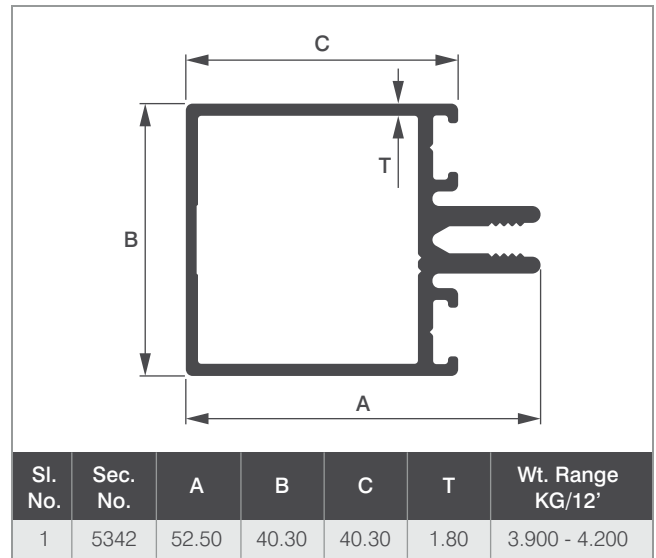
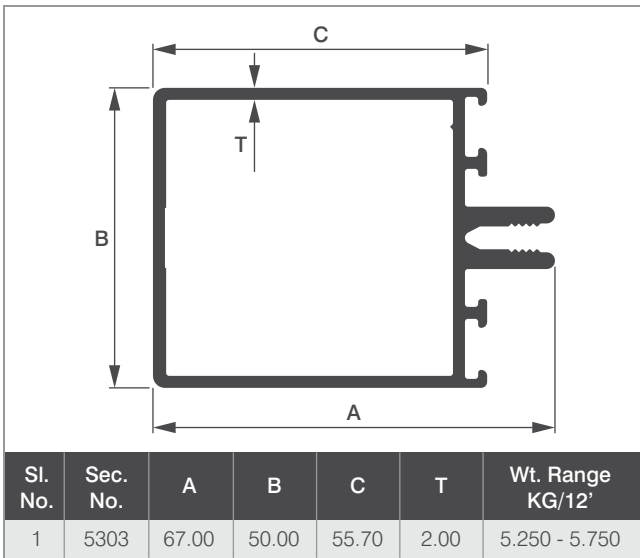
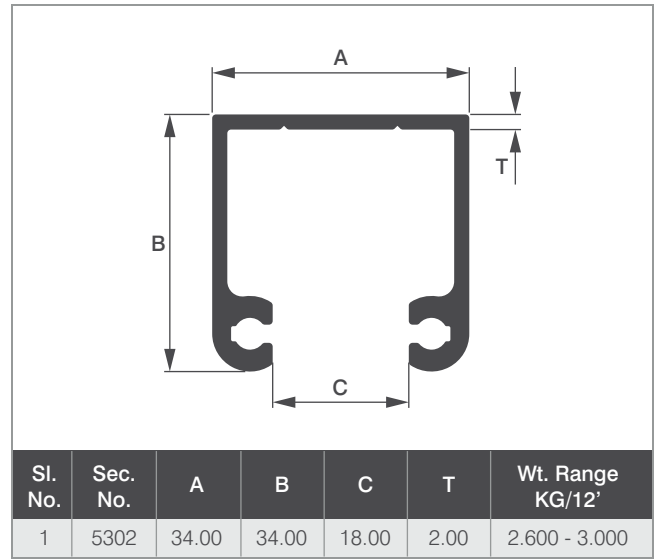
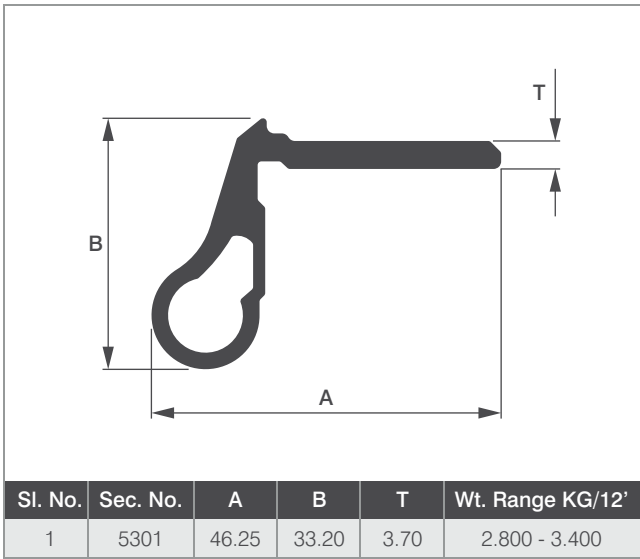



CURTAIN WALLS

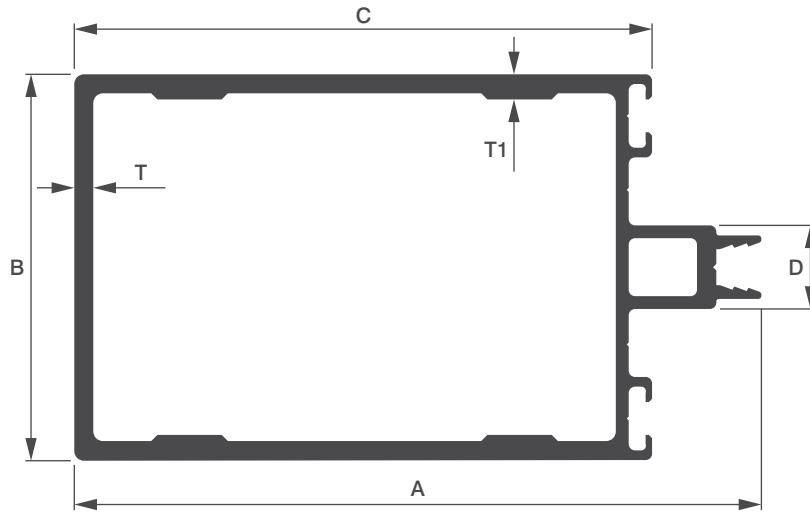

Sl. No.	Sec. No.	A	B	C	D	T	T1	Wt. Range KG/12'
1	5359	106.70	60.00	89.70	13.00	2.95	3.90	9.400 - 9.900

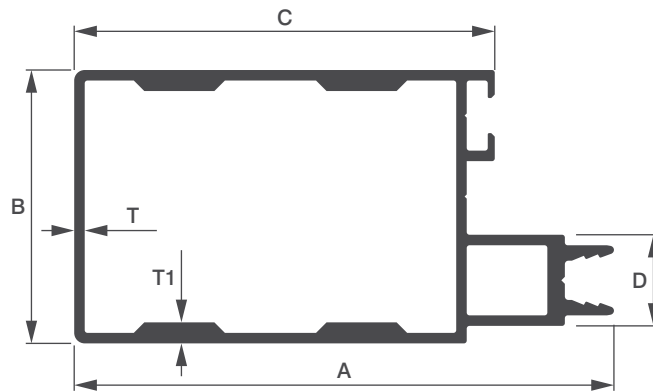

Sl. No.	Sec. No.	A	B	C	D	T	T1	Wt. Range KG/12'
1	5457	77.00	39.00	60.00	13.00	1.50	3.00	4.450 - 4.950

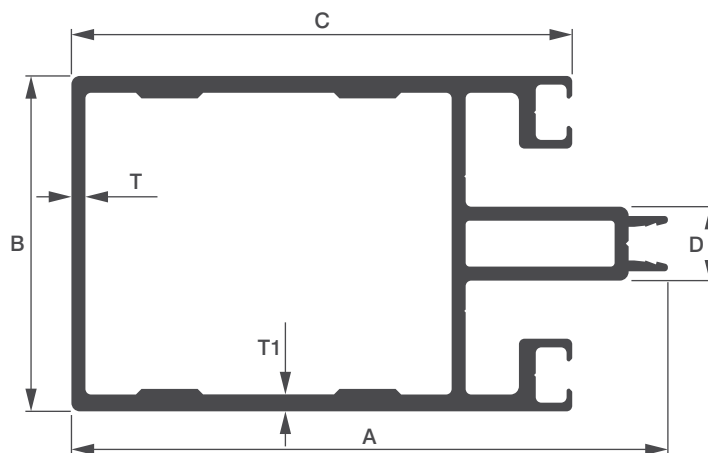

Sl. No.	Sec. No.	A	B	C	D	T	T1	Wt. Range KG/12'
1	5360	106.35	59.80	89.30	13.20	2.50	3.00	10.700 - 11.400



CURTAIN WALLS

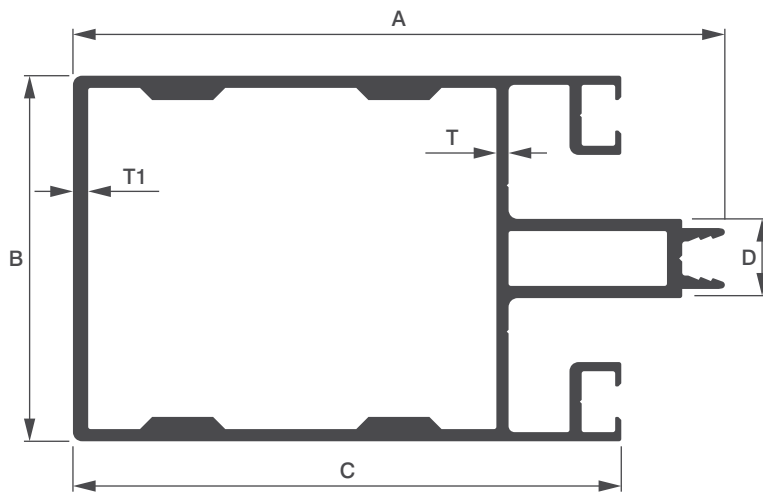

Sl. No.	Sec. No.	A	B	C	D	T	T1	Wt. Range KG/12'
1	5455	107.00	60.00	90.00	12.60	2.00	2.50	9.100 - 9.700

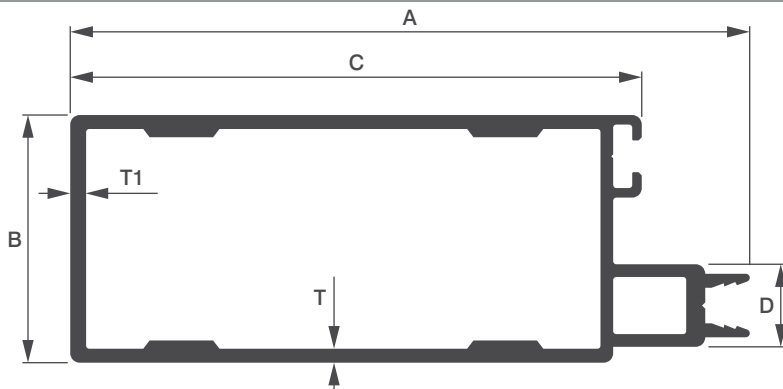

Sl. No.	Sec. No.	A	B	C	D	T	T1	Wt. Range KG/12'
1	5453	107.00	39.00	90.00	13.00	2.20	2.50	7.000 - 7.500

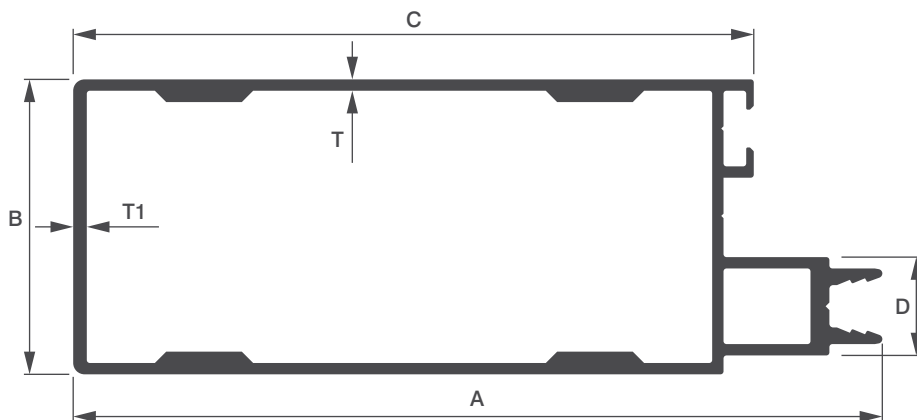

Sl. No.	Sec. No.	A	B	C	D	T	T1	Wt. Range KG/12'
1	5456	107.00	39.00	90.00	13.00	1.50	1.80	5.450 - 5.950



CURTAIN WALLS

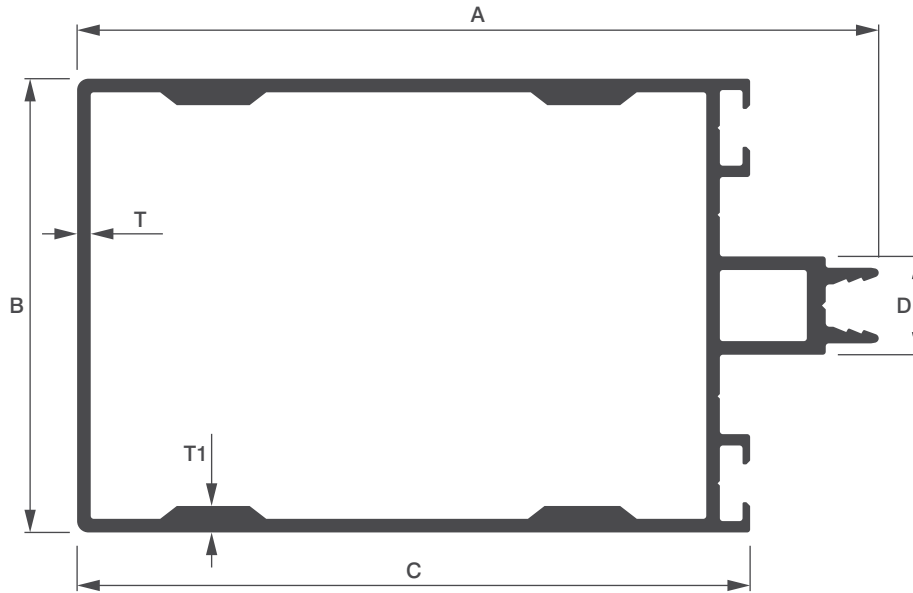

Sl. No.	Sec. No.	A	B	C	D	T	T1	Wt. Range KG/12'
1	5460	106.00	60.00	89.00	13.00	1.80	3.50	7.100 - 7.800

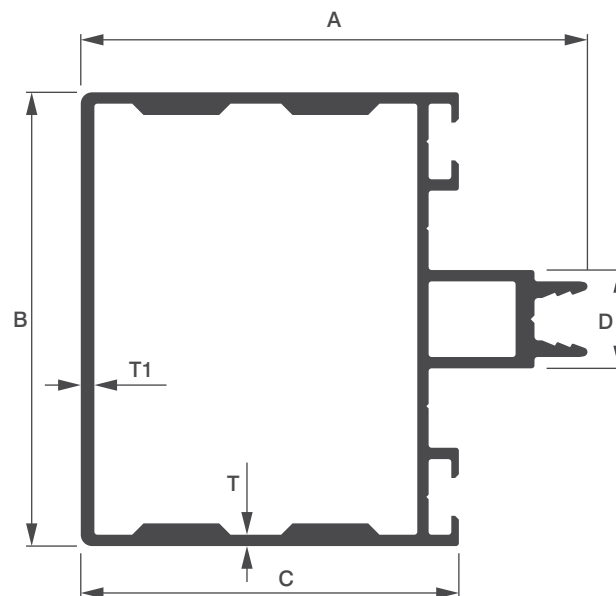

Sl. No.	Sec. No.	A	B	C	D	T	T1	Wt. Range KG/12'
1	5458	67.00	60.00	50.00	13.00	1.50	1.80	5.100 - 5.700



CURTAIN WALLS

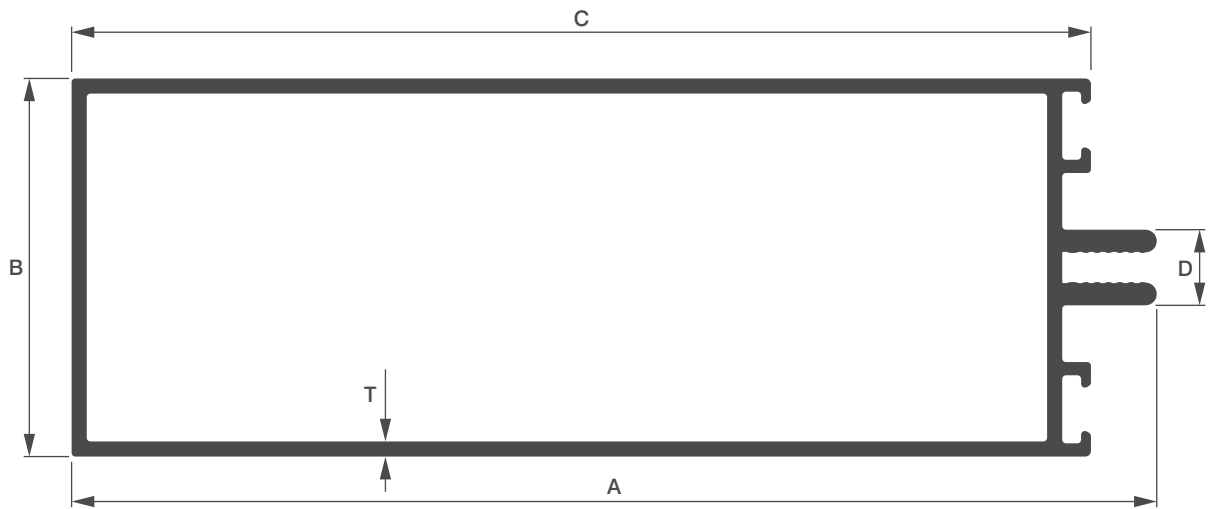

Sl. No.	Sec. No.	A	B	C	D	T	Wt. Range KG/12'
1	5464	143.50	50.00	134.80	10.00	2.00	8.000 - 8.600

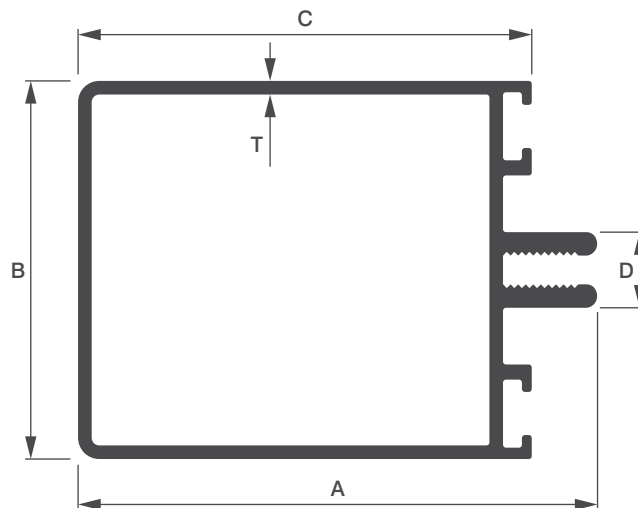

Sl. No.	Sec. No.	A	B	C	D	T	Wt. Range KG/12'
1	5466	68.70	50.00	60.00	10.00	1.80	4.650 - 5.250



CURTAIN WALLS

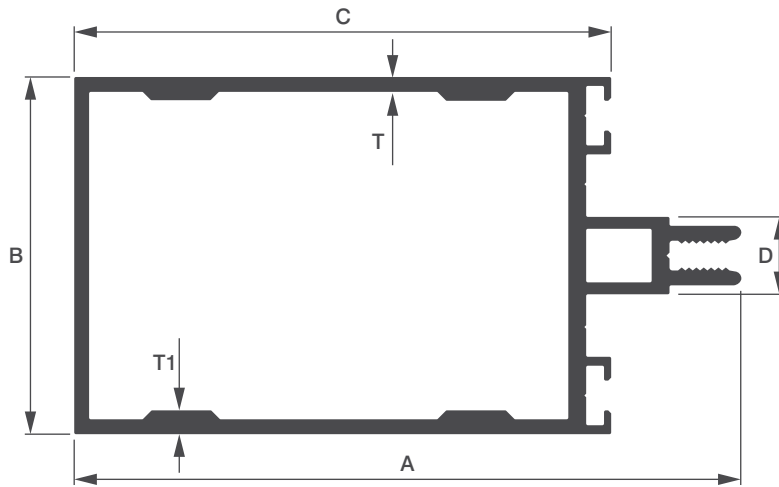

Sl. No.	Sec. No.	A	B	C	D	T	T1	Wt. Range KG/12'
1	5470	111.97	60.00	90.20	13.00	2.50	4.00	9.700 - 10.300

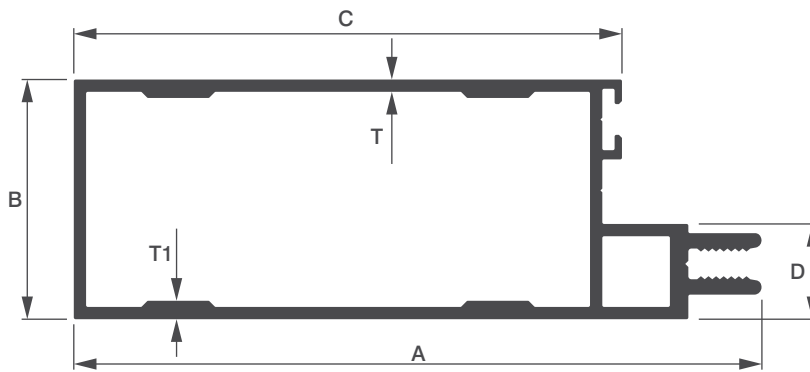

Sl. No.	Sec. No.	A	B	C	D	T	T1	Wt. Range KG/12'
1	5471	111.97	39.00	89.20	15.50	2.00	3.00	6.850 - 7.450

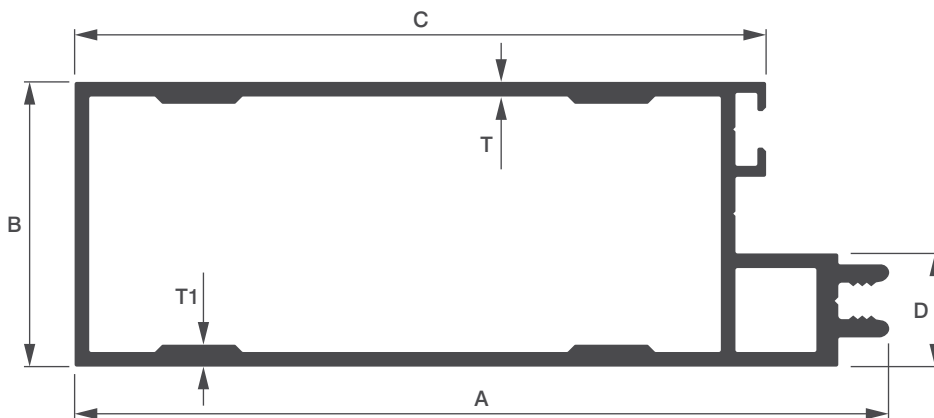

Sl. No.	Sec. No.	A	B	C	D	T	T1	Wt. Range KG/12'
1	5472	111.50	39.00	94.73	15.50	2.00	3.00	6.800 - 7.400



CURTAIN WALLS

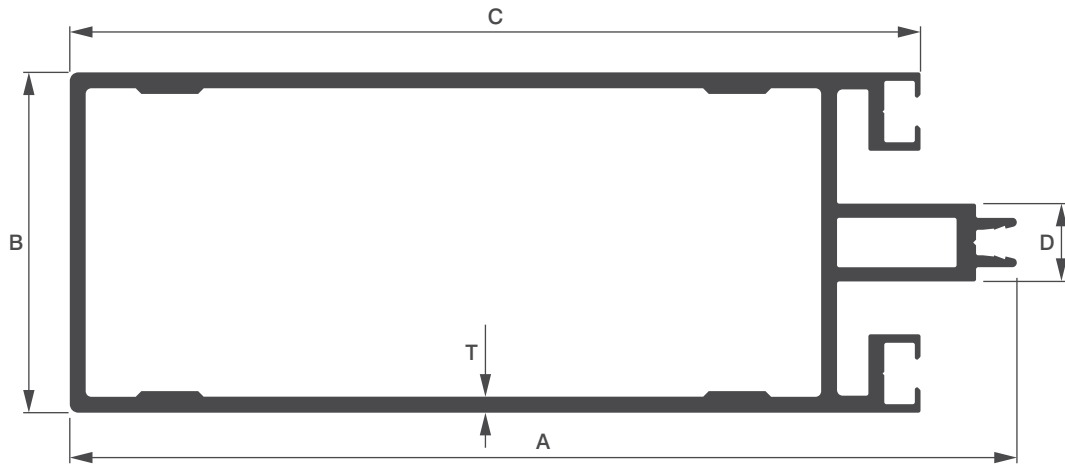

Sl. No.	Sec. No.	A	B	C	D	T	Wt. Range KG/12'
1	5483	167.00	60.00	150.00	13.72	2.80	14.200 - 14.700

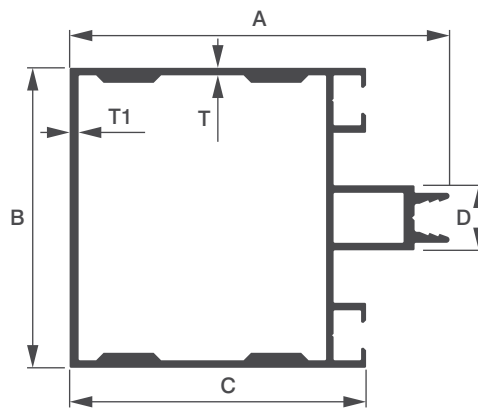

Sl. No.	Sec. No.	A	B	C	D	T	T1	Wt. Range KG/12'
1	5477	76.00	60.00	59.30	13.00	1.50	1.80	5.500 - 6.200

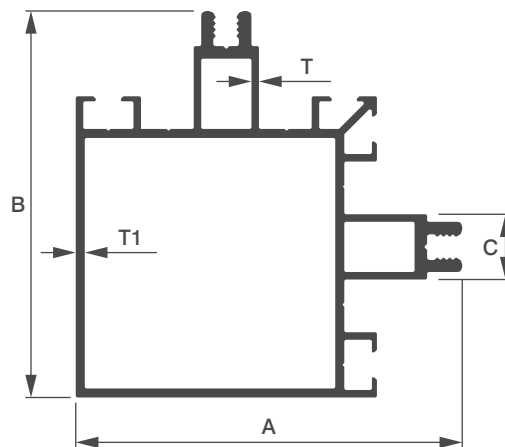

Sl. No.	Sec. No.	A	B	C	T	T1	Wt. Range KG/12'
1	5492	77.00	77.00	13.00	1.50	1.80	6.750 - 7.150



CURTAIN WALLS

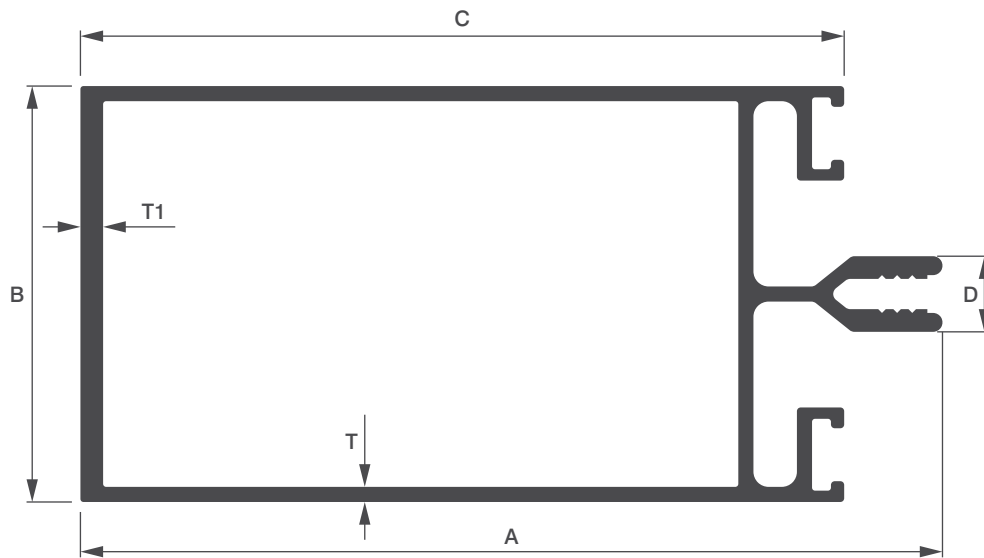

Sl. No.	Sec. No.	A	B	C	D	T	T1	Wt. Range KG/12'
1	5579	114.00	55.00	101.00	10.00	2.00	3.00	8.100 - 8.700

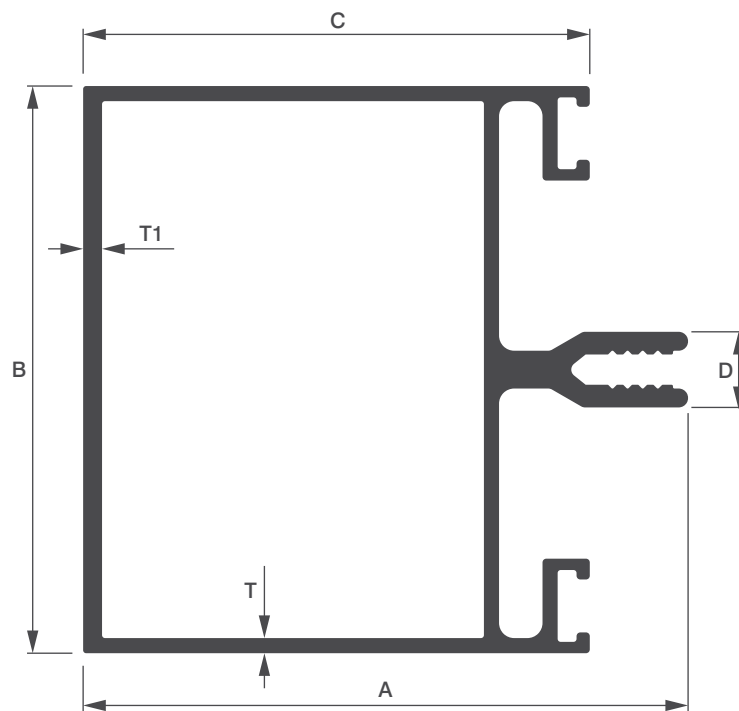

Sl. No.	Sec. No.	A	B	C	D	T	T1	Wt. Range KG/12'
1	5648	80.00	75.00	67.00	10.00	2.00	2.50	7.800 - 8.200



CURTAIN WALLS

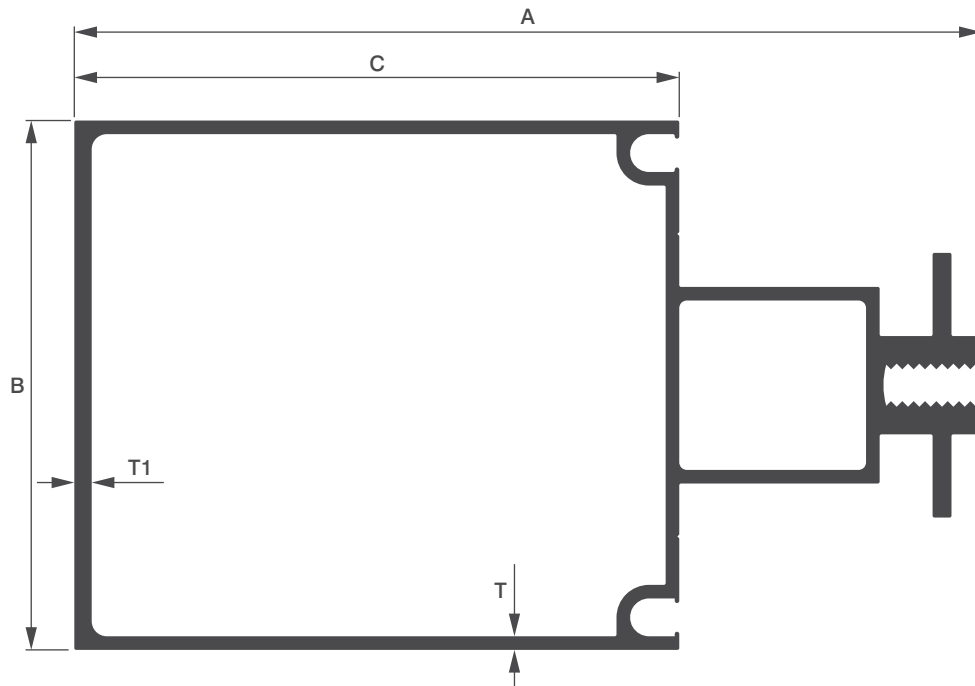

Sl. No.	Sec. No.	A	B	C	T	T1	Wt. Range KG/12'
1	5584	120.00	70.00	80.00	1.80	2.30	8.700 - 9.300
2	5585	90.00	70.00	50.00	1.80	2.30	7.650 - 8.350

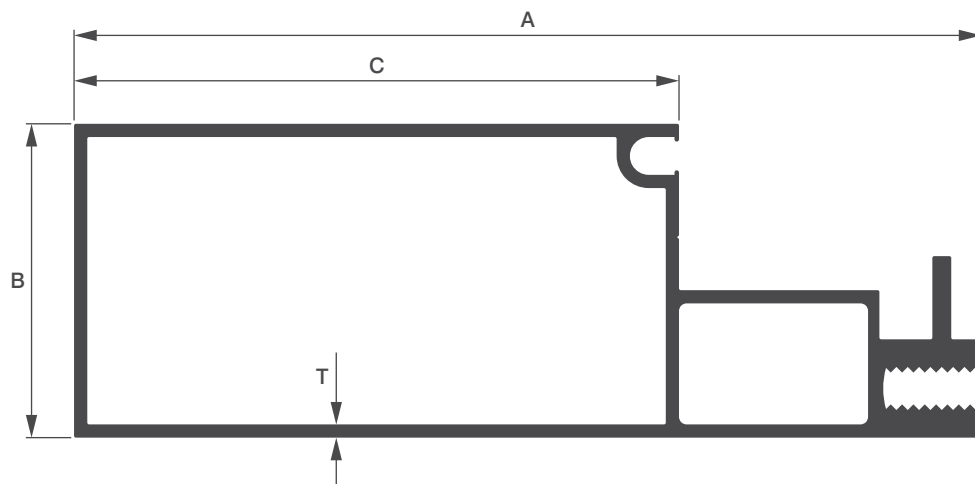

Sl. No.	Sec. No.	A	B	C	T	Wt. Range KG/12'
1	5583	120.00	41.50	80.00	1.75	6.700 - 7.300
2	5582	90.00	41.50	50.00	1.75	5.700 - 6.300



CURTAIN WALLS

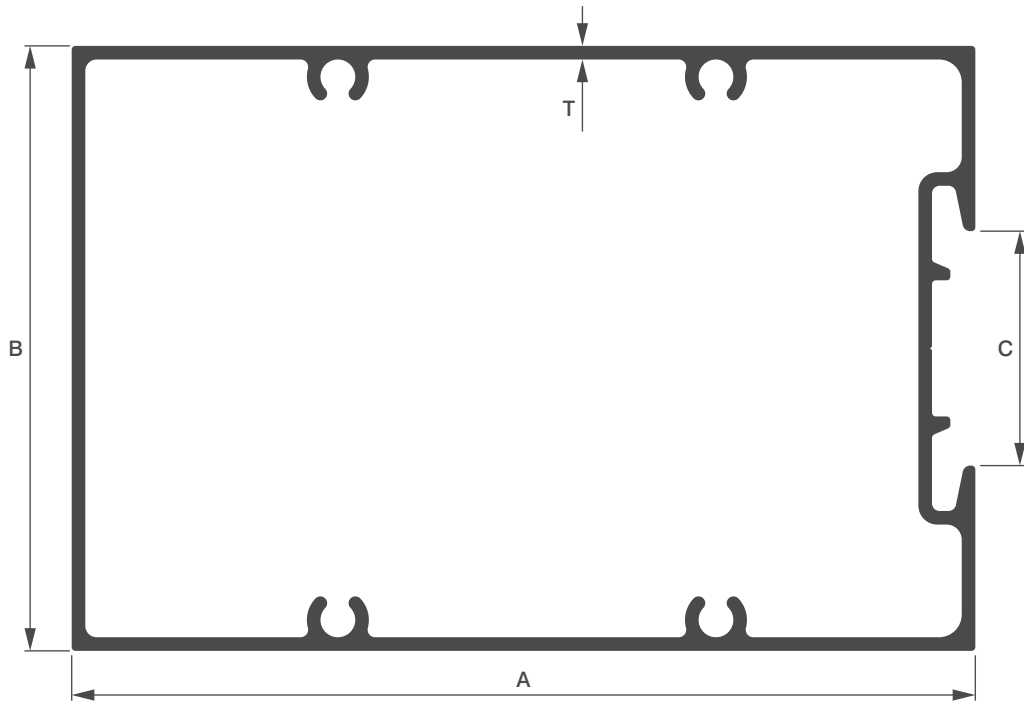

Sl. No.	Sec. No.	A	B	C	T	Wt. Range KG/12'
1	5595	119.50	80.00	31.00	1.80	8.400 - 8.800

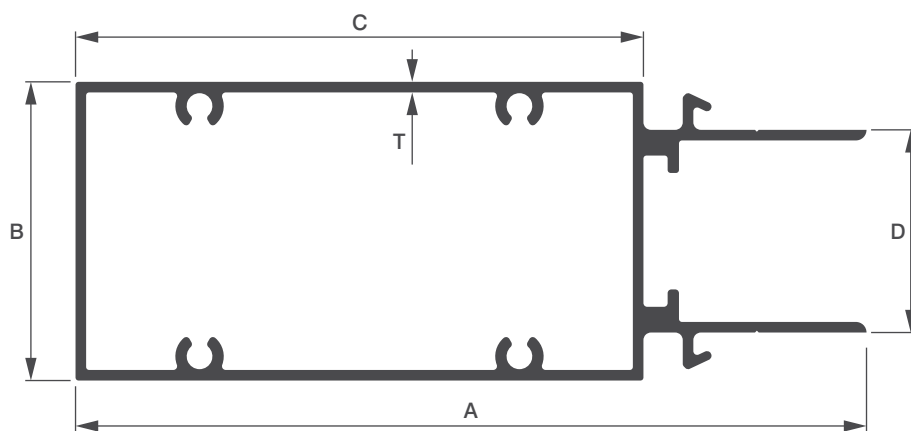

Sl. No.	Sec. No.	A	B	C	D	T	Wt. Range KG/12'
1	5591	104.60	39.50	75.10	26.80	1.40	4.900 - 5.400



CURTAIN WALLS

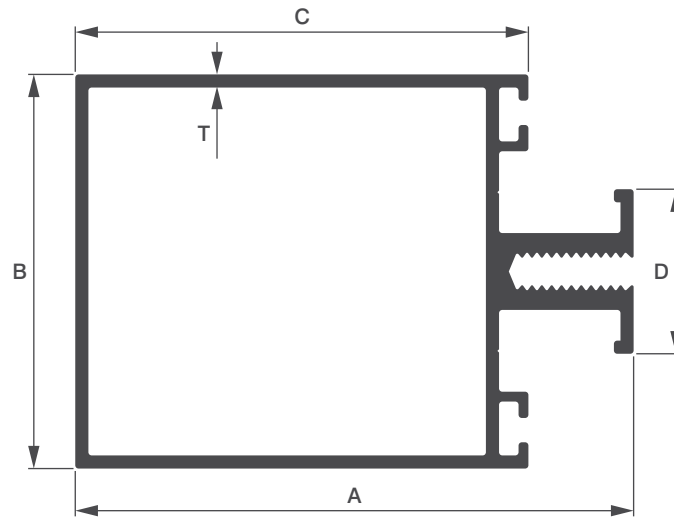

Sl. No.	Sec. No.	A	B	C	D	T	Wt. Range KG/12'
1	5611	85.00	60.00	69.00	25.00	2.00	6.950 - 7.350

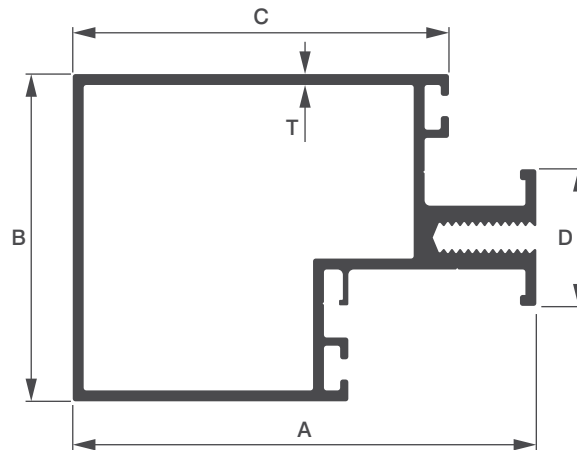

Sl. No.	Sec. No.	A	B	C	D	T	Wt. Range KG/12'
1	5612	85.00	60.00	69.00	24.50	2.00	7.000 - 7.400

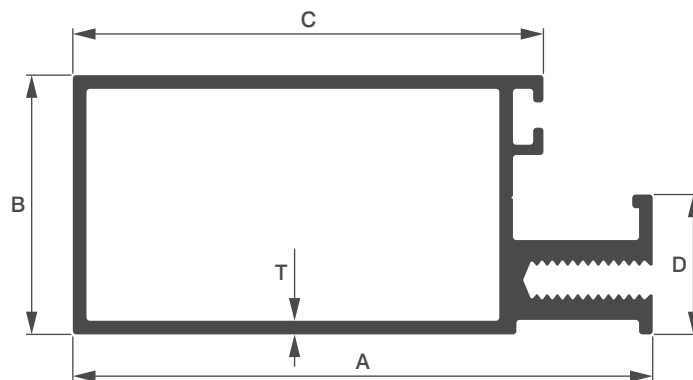

Sl. No.	Sec. No.	A	B	C	D	T	Wt. Range KG/12'
1	5613	85.00	38.00	69.00	20.50	2.00	5.750 - 6.150



CURTAIN WALLS

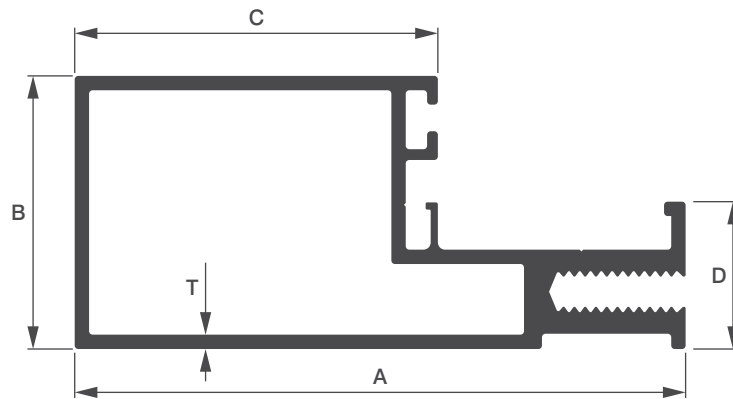

Sl. No.	Sec. No.	A	B	C	D	T	Wt. Range KG/12'
1	5614	85.00	38.00	50.50	20.50	2.00	5.850 - 6.250

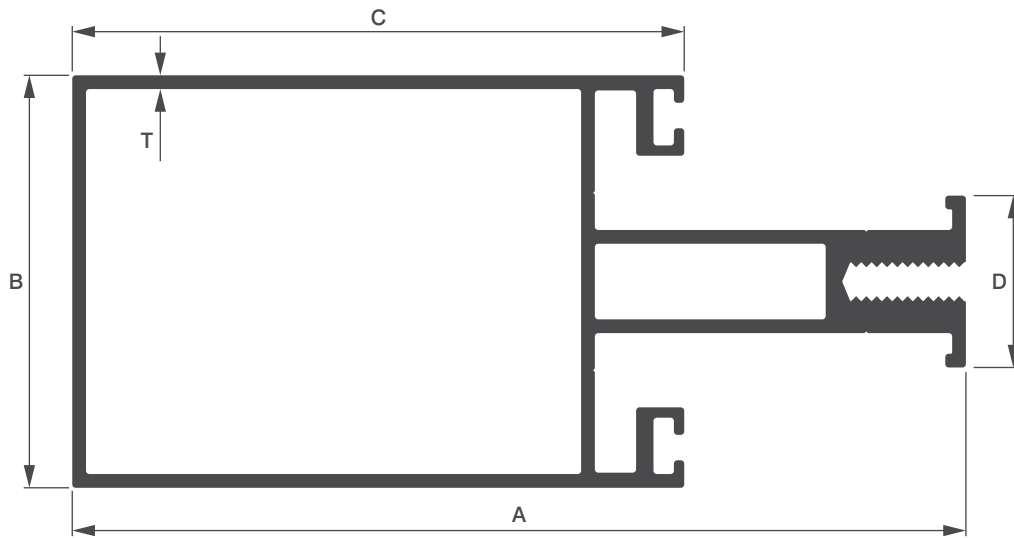

Sl. No.	Sec. No.	A	B	C	D	T	Wt. Range KG/12'
1	5609	130.00	60.00	89.00	25.00	2.00	10.200 - 10.600

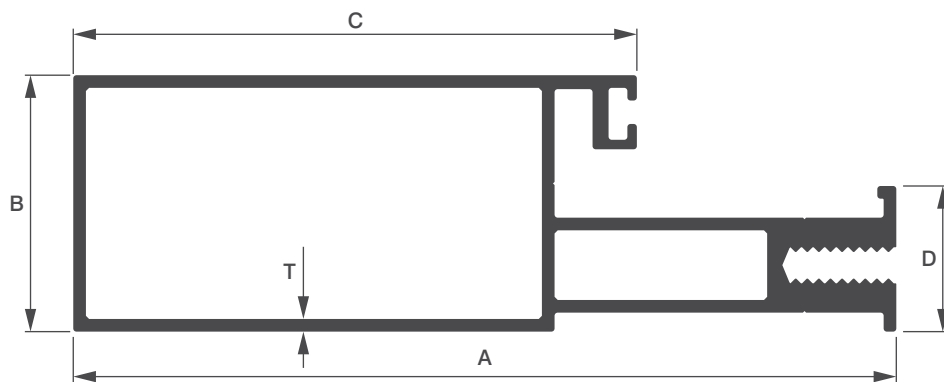

Sl. No.	Sec. No.	A	B	C	D	T	Wt. Range KG/12'
1	5634	130.00	40.50	89.00	23.00	2.00	8.750 - 9.250



CURTAIN WALLS

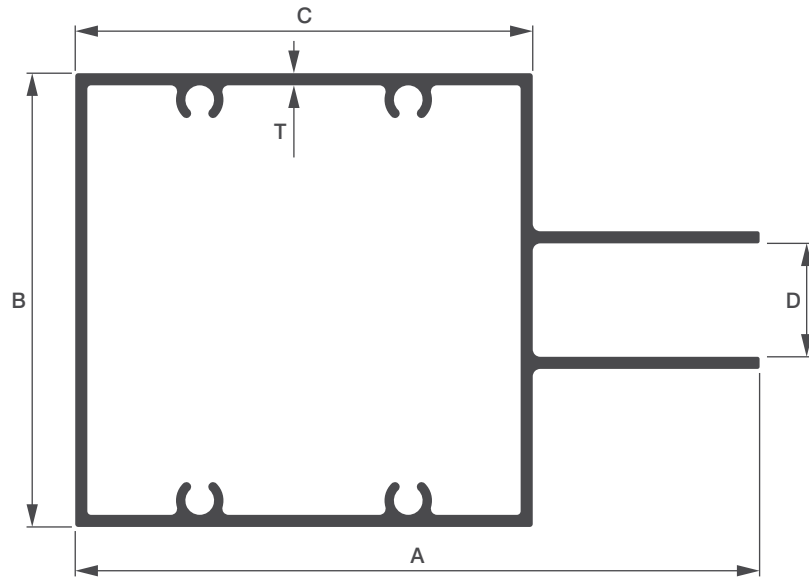

Sl. No.	Sec. No.	A	B	C	D	T	Wt. Range KG/12'
1	5620	90.50	60.00	60.50	15.00	1.60	5.150 - 5.650

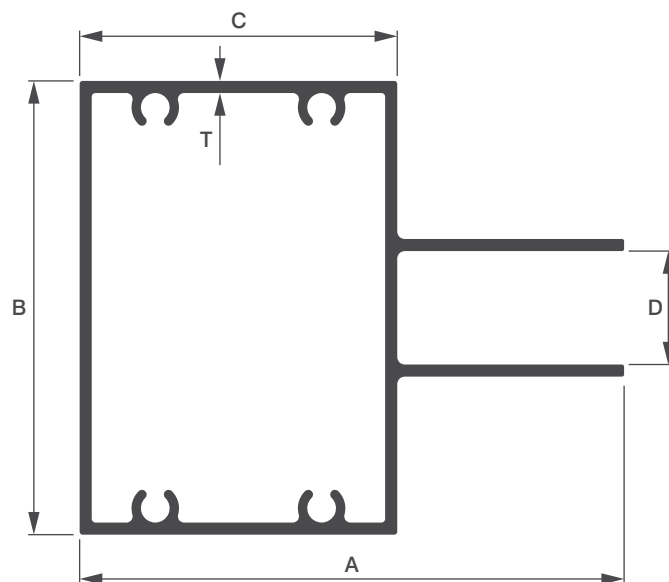

Sl. No.	Sec. No.	A	B	C	D	T	Wt. Range KG/12'
1	5621	72.00	60.00	42.00	15.00	1.60	4.550 - 4.950



CURTAIN WALLS

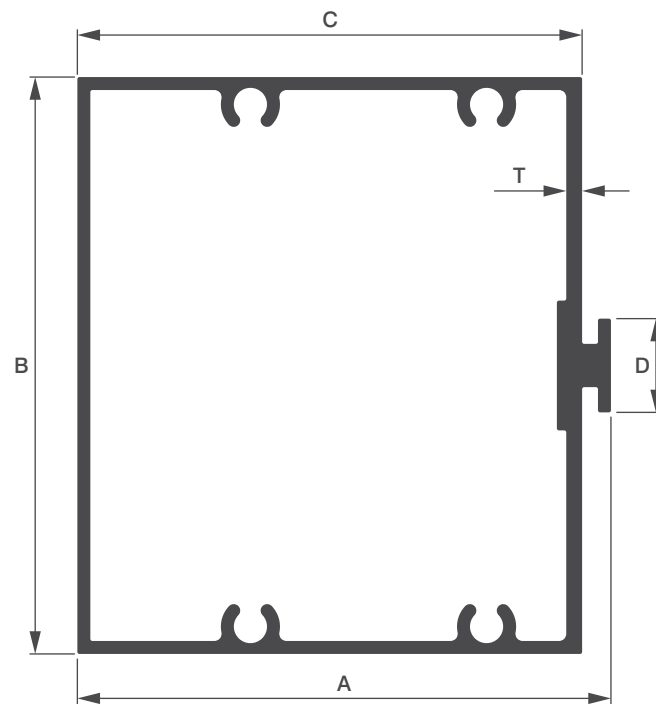

Sl. No.	Sec. No.	A	B	C	D	T	Wt. Range KG/12'
1	5625	74.00	80.00	70.00	13.00	2.20	6.850 - 7.350

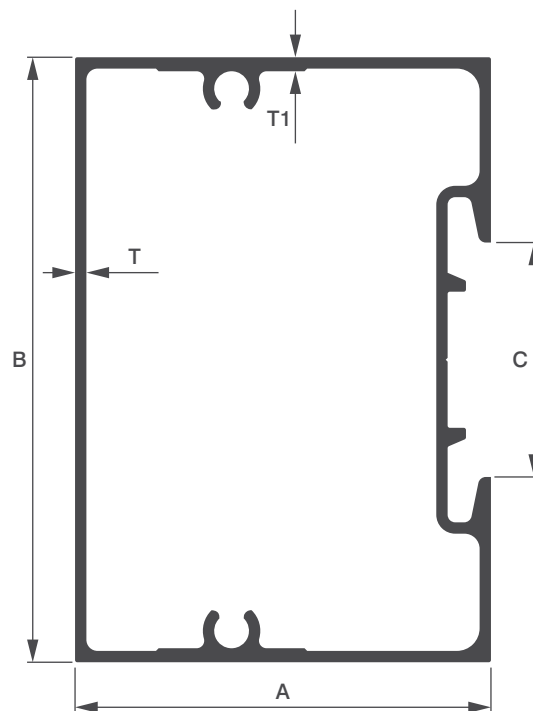

Sl. No.	Sec. No.	A	B	C	T	T1	Wt. Range KG/12'
1	5577	55.00	80.00	31.00	1.50	1.85	4.900 - 5.500



CURTAIN WALLS

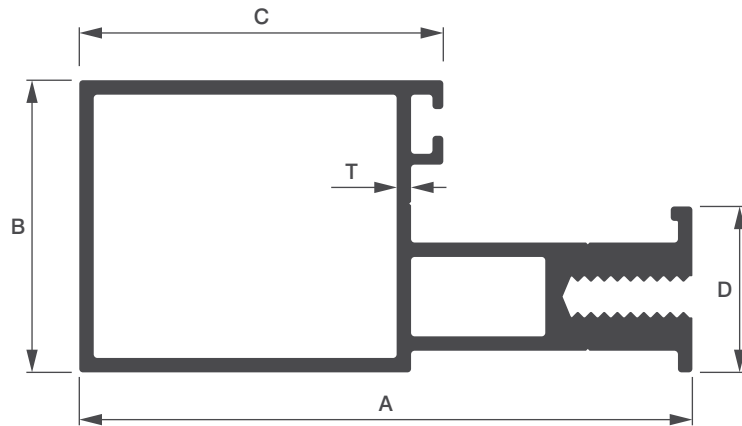

Sl. No.	Sec. No.	A	B	C	D	T	Wt. Range KG/12'
1	5635	85.00	40.50	50.50	23.00	2.00	6.550 - 7.050

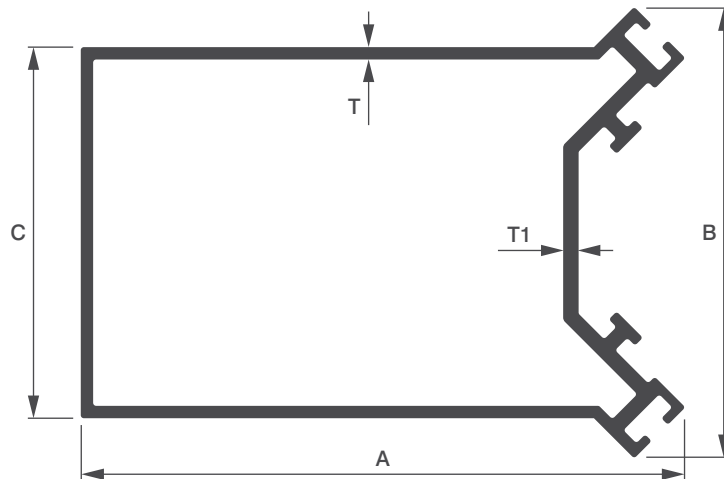

Sl. No.	Sec. No.	A	B	C	T	T1	Wt. Range KG/12'
1	5636	97.55	72.60	60.00	2.00	2.50	7.350 - 7.750

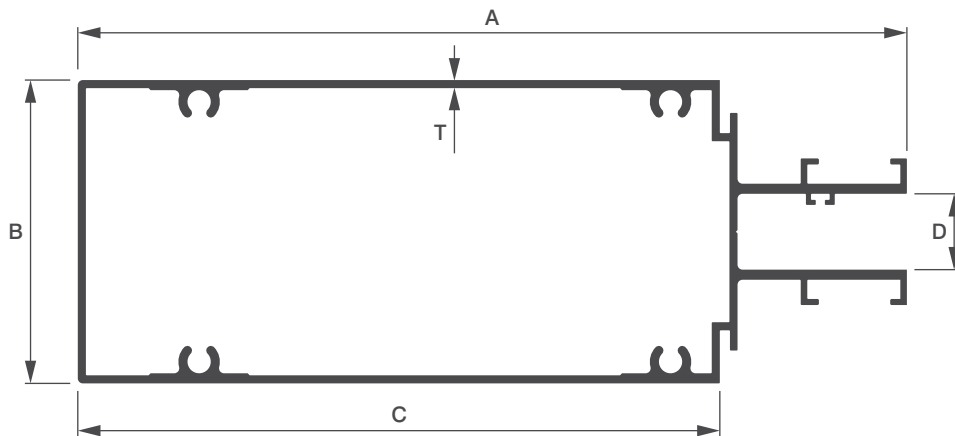

Sl. No.	Sec. No.	A	B	C	D	T	Wt. Range KG/12'
1	5515	164.00	60.00	127.00	15.00	1.60	8.900 - 9.500



CURTAIN WALLS

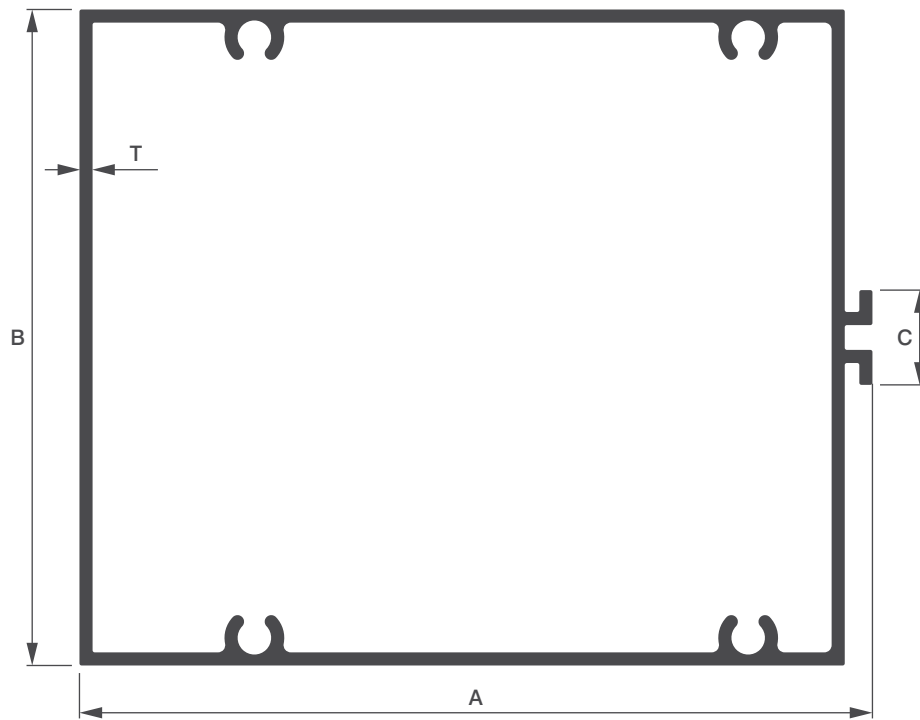

Sl. No.	Sec. No.	A	B	C	T	Wt. Range KG/12'
1	5640	108.80	90.00	13.00	1.80	7.800 - 8.200

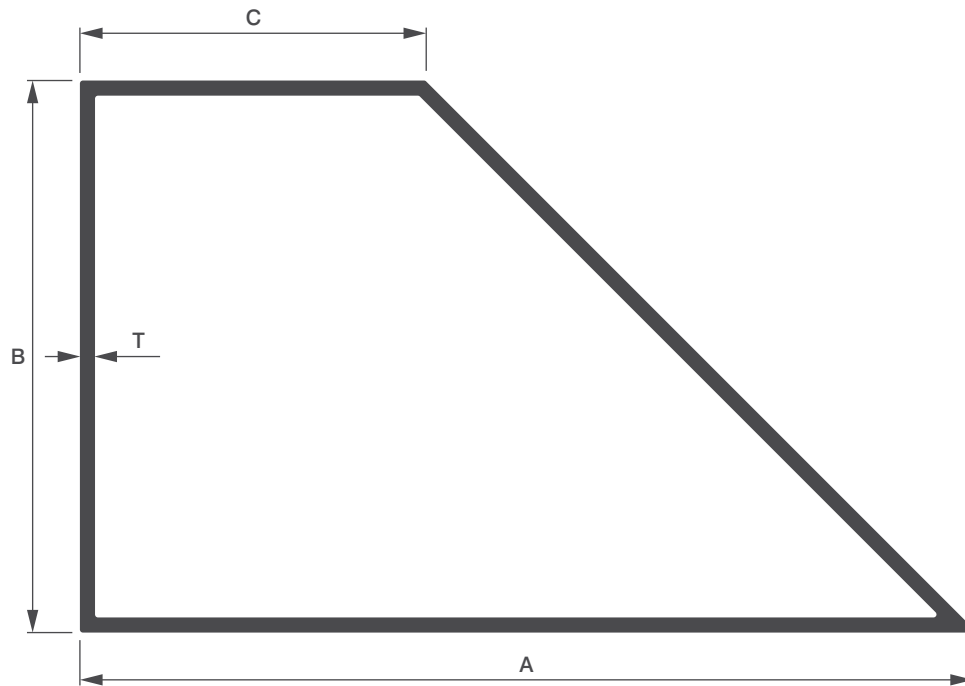

Sl. No.	Sec. No.	A	B	C	T	Wt. Range KG/12'
1	7825	118.10	73.00	45.80	2.00	6.500 - 7.300



CURTAIN WALLS

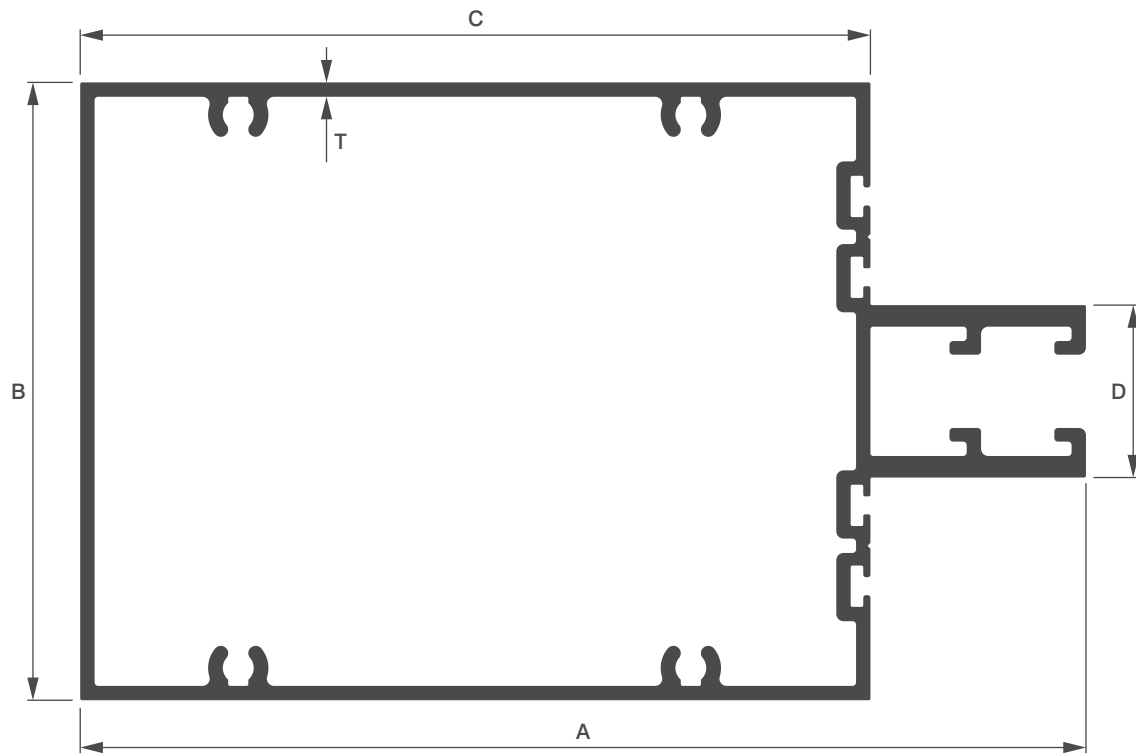

Sl. No.	Sec. No.	A	B	C	D	T	Wt. Range KG/12'
1	7811	140.00	86.00	110.00	24.00	2.00	11.300 - 11.800

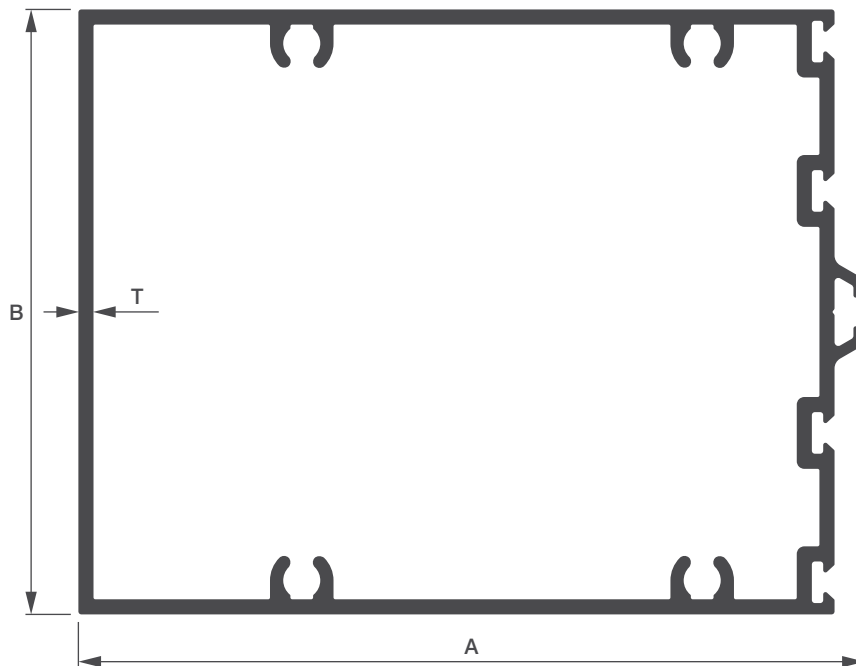

Sl. No.	Sec. No.	A	B	T	Wt. Range KG/12'
1	7812	104.00	80.00	2.00	8.400 - 8.800



CURTAIN WALLS

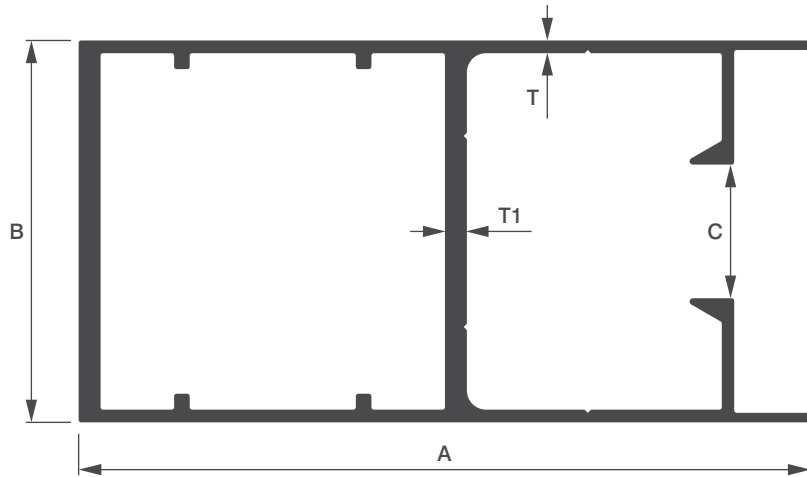

Sl. No.	Sec. No.	A	B	C	T	T1	Wt. Range KG/12'
1	7813	115.00	60.00	21.00	2.00	3.45	9.400 - 9.800

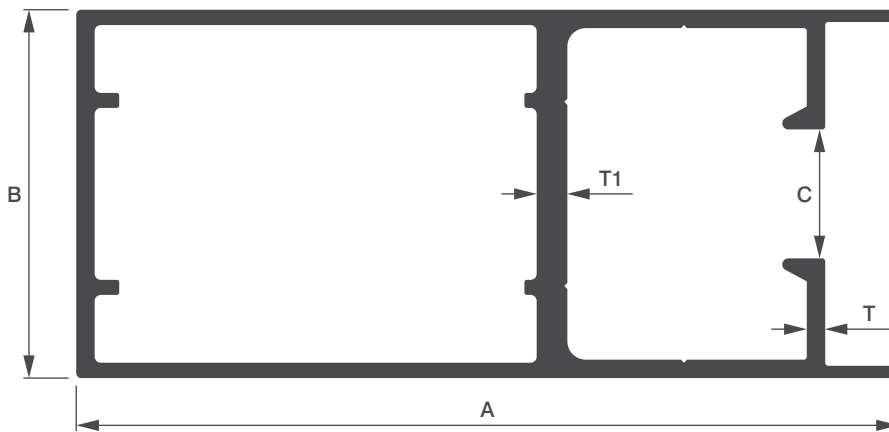

Sl. No.	Sec. No.	A	B	C	T	T1	Wt. Range KG/12'
1	7814	134.00	60.00	21.00	3.00	5.00	12.700 - 13.300

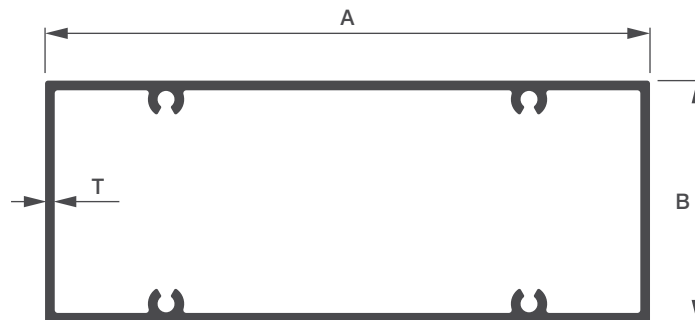

Sl. No.	Sec. No.	A	B	T	Wt. Range KG/12'
1	7839	100.00	40.00	1.60	4.800 - 5.600



CURTAIN WALLS

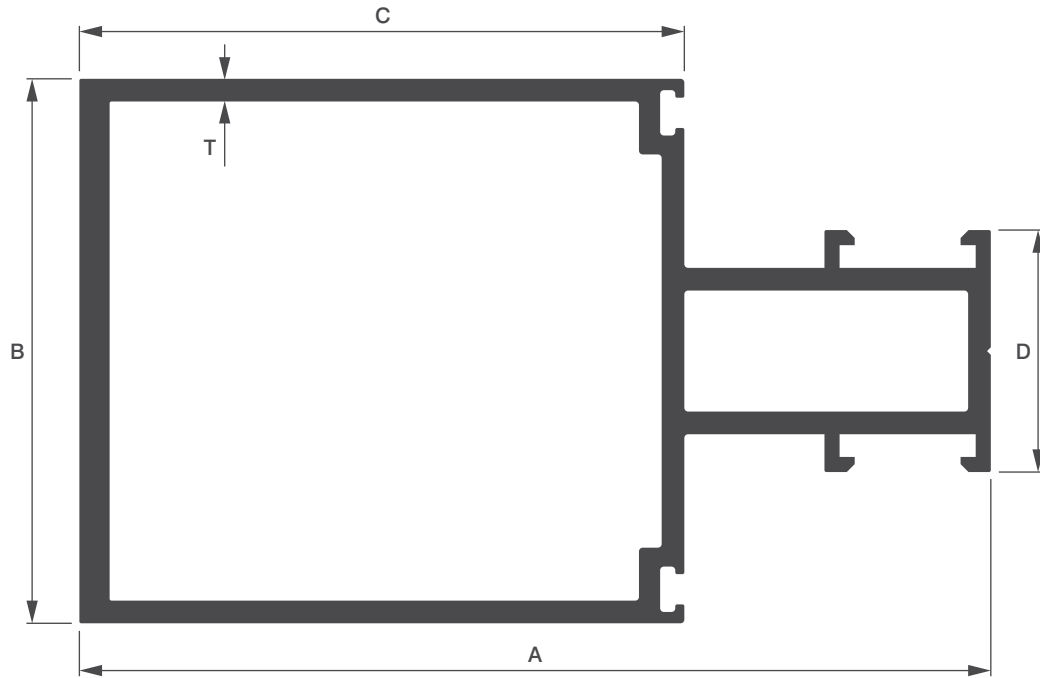

Sl. No.	Sec. No.	A	B	C	D	T	Wt. Range KG/12'
1	7822	120.53	72.00	80.00	32.00	3.00	12.750 - 13.550

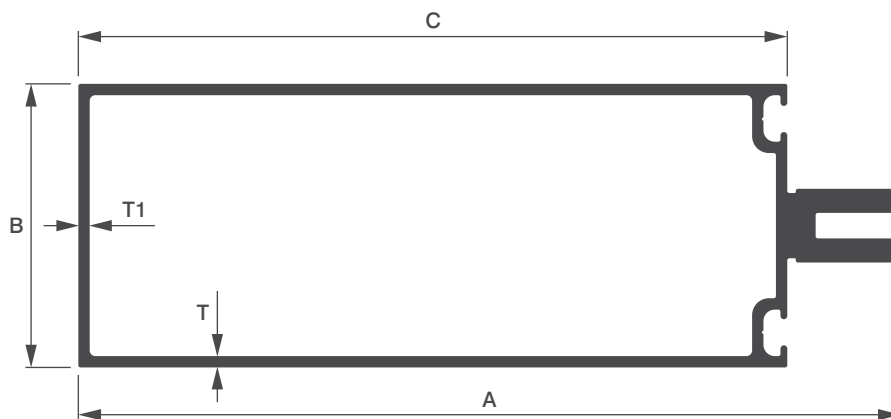

Sl. No.	Sec. No.	A	B	C	T	T1	Wt. Range KG/12'
1	7823	145.00	50.00	125.00	2.00	2.00	8.800 - 9.500
2	7824	145.00	50.00	125.00	2.50	3.50	11.000 - 11.800



CURTAIN WALLS

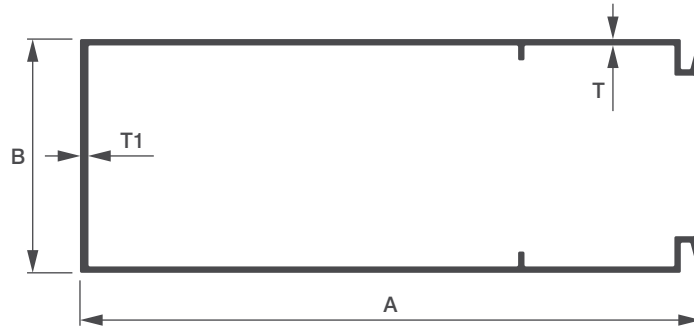

Sl. No.	Sec. No.	A	B	T	T1	Wt. Range KG/12'
1	7843	146.00	54.95	1.50	2.00	6.300 - 6.900

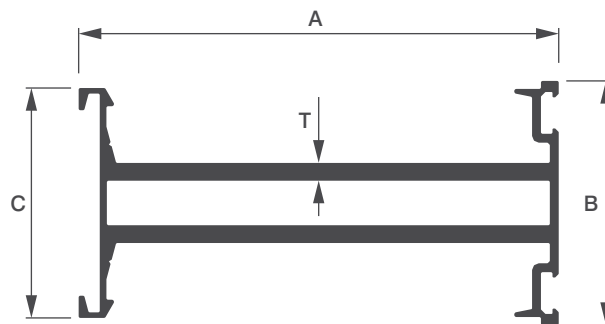

Sl. No.	Sec. No.	A	B	C	T	Wt. Range KG/12'
1	7844	108.06	54.95	51.75	4.00	10.600 - 11.200

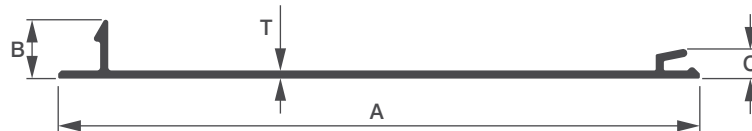

Sl. No.	Sec. No.	A	B	C	T	Wt. Range KG/12'
1	7845	102.56	9.40	4.73	1.30	1.500 - 2.300

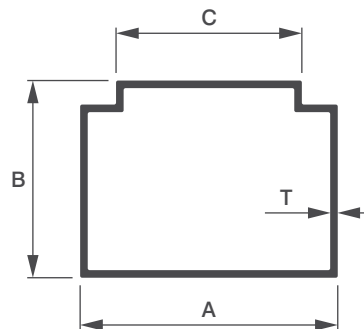

Sl. No.	Sec. No.	A	B	C	T	Wt. Range KG/12'
1	7848	50.95	39.00	36.75	1.50	2.550 - 3.000



CURTAIN WALLS

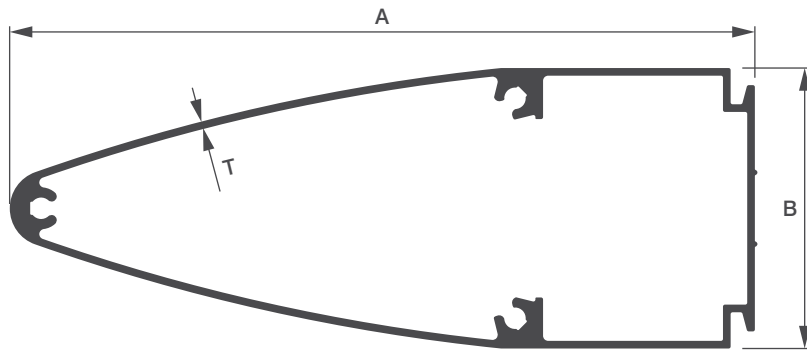

Sl. No.	Sec. No.	A	B	T	Wt. Range KG/12'
1	7846	146.00	54.95	1.50	6.900 - 7.500

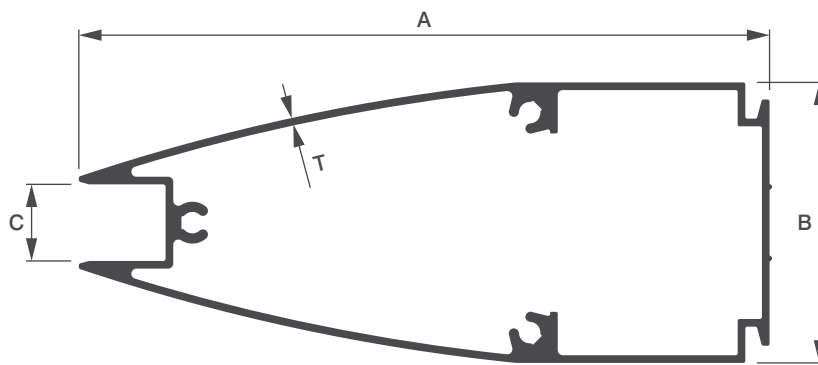

Sl. No.	Sec. No.	A	B	C	T	Wt. Range KG/12'
1	7847	135.32	54.95	15.00	1.50	7.000 - 7.700

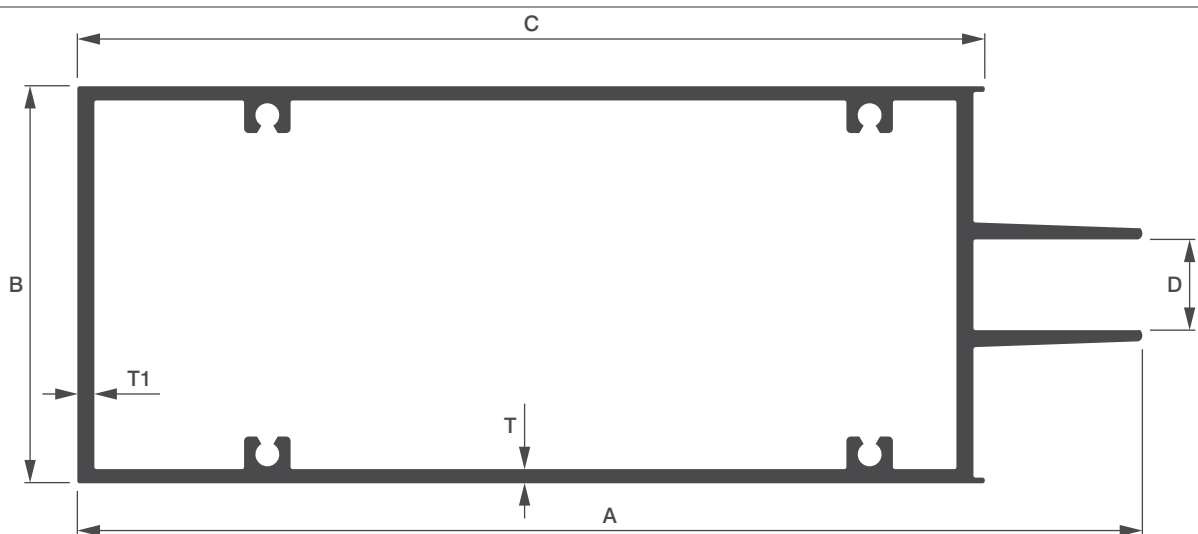

Sl. No.	Sec. No.	A	B	C	D	T	T1	Wt. Range KG/12'
1	7872	188.00	70.00	160.00	16.00	2.50	3.00	14.300 - 14.700