

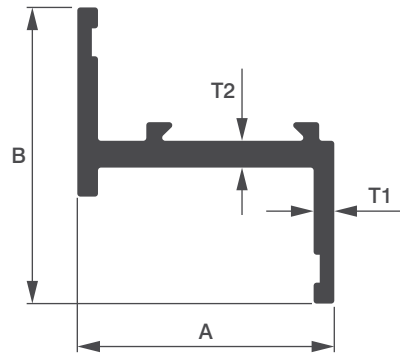

CASEMENT WINDOWS

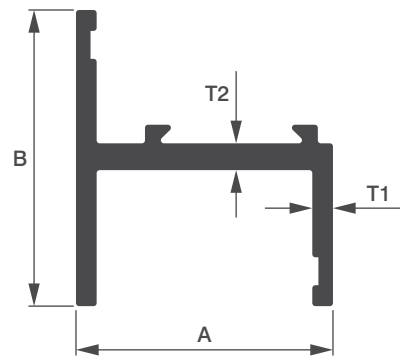

Sl. No.	Sec. No.	A	B	T1	T2	Wt. Range KG/12'
1	1841	33.00	39.00	1.65	1.95	1.300 - 1.700
2	1841/H	33.00	39.00	2.10	2.90	1.800 - 2.100
3	1844	33.00	39.00	2.80	3.60	2.300 - 2.600
4	1844/H	33.00	39.00	3.50	3.90	2.700 - 3.100



Sl. No.	Sec. No.	A	B	T1	T2	Wt. Range KG/12'
1	1842	33.00	39.00	1.85	1.95	1.300 - 1.700
2	1842/H	33.00	39.00	2.20	2.40	2.100 - 2.400
3	1845	33.00	39.00	2.90	3.10	2.700 - 3.100

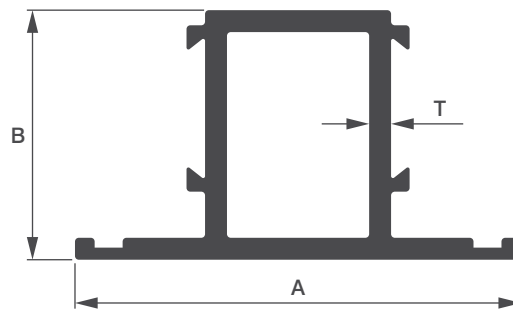

Sl. No.	Sec. No.	A	B	T	Wt. Range KG/12'
1	1843	59.00	33.00	1.55	2.500 - 2.800
2	1846	59.00	33.00	2.50	3.900 - 4.200



CASEMENT WINDOWS

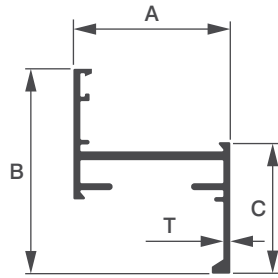

Sl. No.	Sec. No.	A	B	C	T	Wt. Range KG/12'
1	1847/L	34.00	44.40	28.50	1.20	1.350 - 1.550
2	1847	34.00	44.40	28.50	1.50	1.800 - 2.000

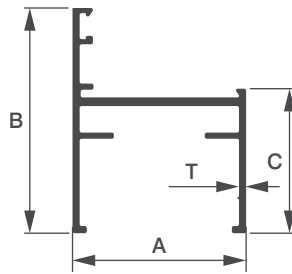

Sl. No.	Sec. No.	A	B	C	T	Wt. Range KG/12'
1	1848/L	34.00	44.10	28.30	1.20	1.350 - 1.550
2	1848	34.00	44.10	28.30	1.40	1.800 - 2.200

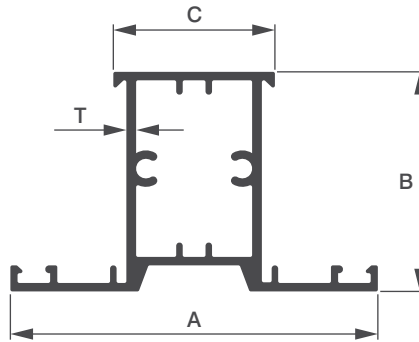

Sl. No.	Sec. No.	A	B	C	T	Wt. Range KG/12'
1	1849/L	56.40	33.70	24.80	1.20	2.450 - 2.650
2	1849	56.40	33.70	24.80	1.50	2.700 - 3.000

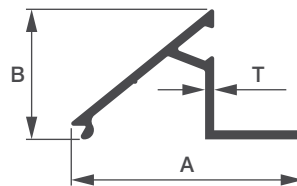

Sl. No.	Sec. No.	A	B	T	Wt. Range KG/12'
1	1850/L	30.70	17.20	1.00	0.500 - 0.580
2	1850	30.70	17.20	1.20	0.600 - 0.680



CASEMENT WINDOWS

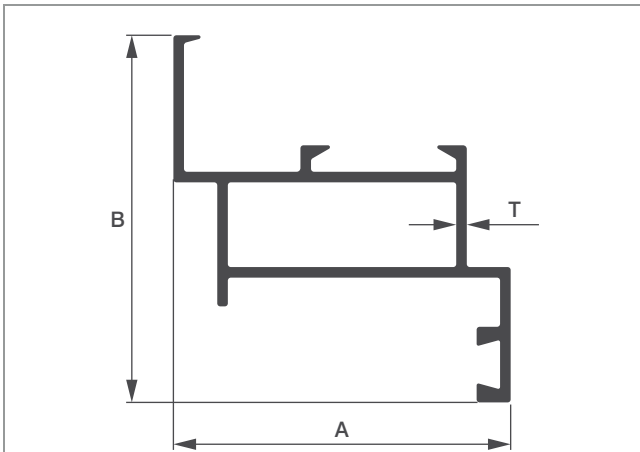

Sl. No.	Sec. No.	A	B	T	Wt. Range KG/12'
1	1871	44.60	48.55	1.40	2.200 - 2.500

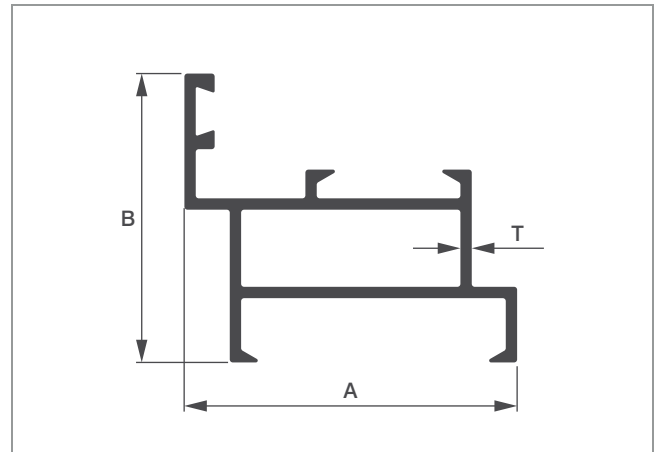

Sl. No.	Sec. No.	A	B	T	Wt. Range KG/12'
1	1872	44.00	38.20	1.50	2.200 - 2.600

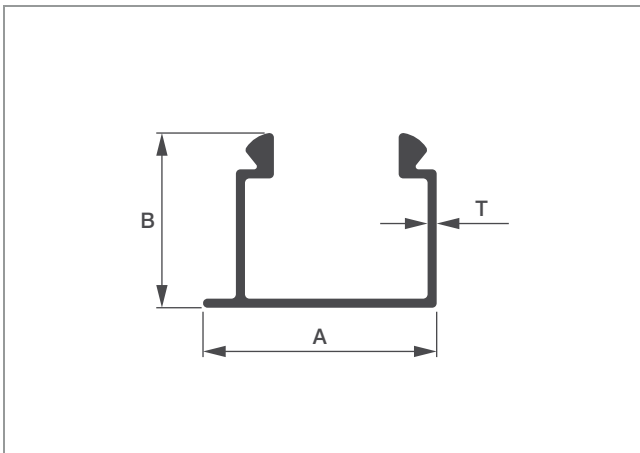

Sl. No.	Sec. No.	A	B	T	Wt. Range KG/12'
1	1873	20.60	15.40	0.80	0.450 - 0.600

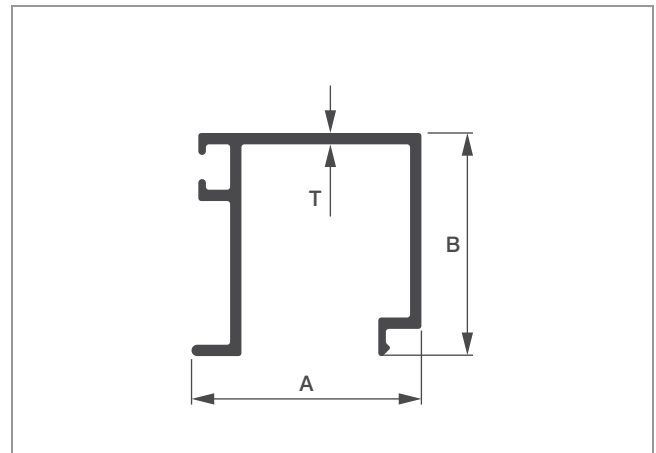

Sl. No.	Sec. No.	A	B	T	Wt. Range KG/12'
1	1874	30.40	29.50	1.50	1.400 - 1.750

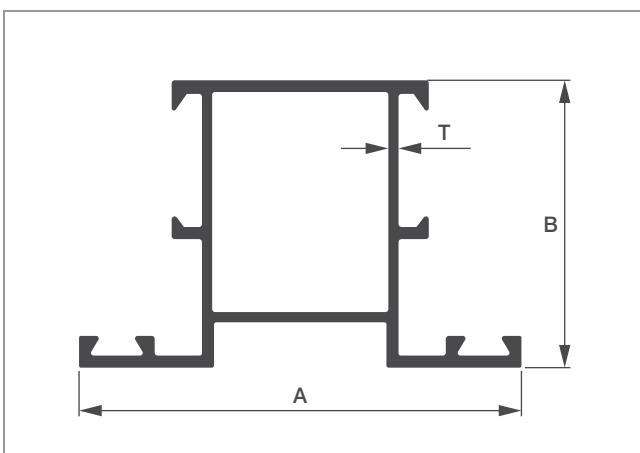

Sl. No.	Sec. No.	A	B	T	Wt. Range KG/12'
1	8830	58.50	38.00	1.35	2.800 - 3.000

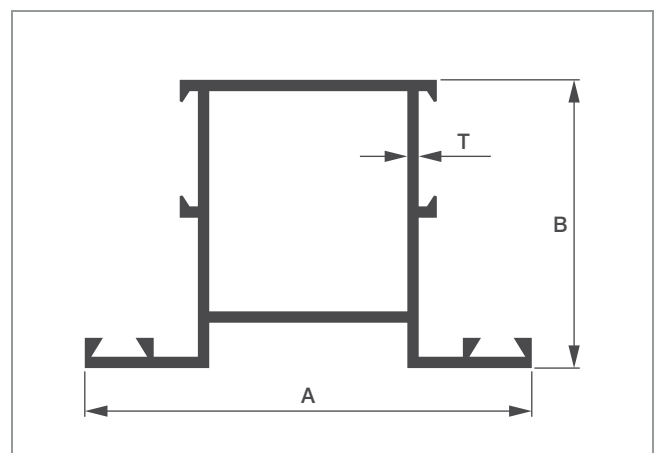

Sl. No.	Sec. No.	A	B	T	Wt. Range KG/12'
1	7284	59.11	38.12	1.50	2.700 - 2.900



CASEMENT WINDOWS

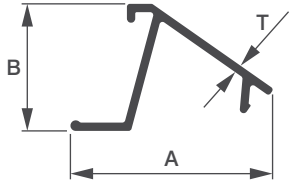

Sl. No.	Sec. No.	A	B	T	Wt. Range KG/12'
1	1877	26.73	16.80	1.10	0.450 - 0.480

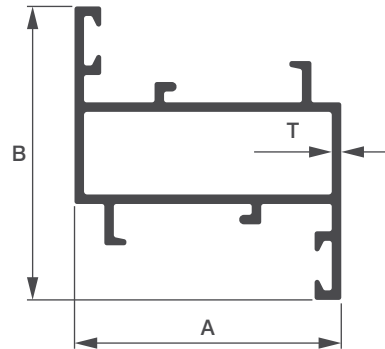

Sl. No.	Sec. No.	A	B	T	Wt. Range KG/12'
1	1880	42.00	46.20	1.50	2.600 - 3.100

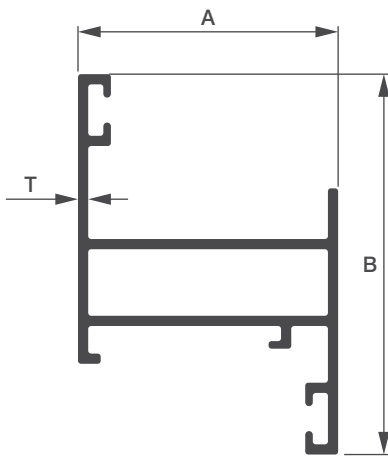

Sl. No.	Sec. No.	A	B	T	Wt. Range KG/12'
1	1878	34.40	50.30	1.35	2.000 - 2.500

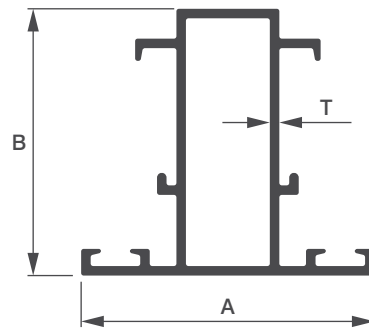

Sl. No.	Sec. No.	A	B	T	Wt. Range KG/12'
1	1881	46.20	42.00	1.50	2.700 - 3.000

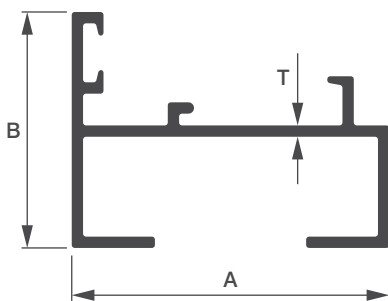

Sl. No.	Sec. No.	A	B	T	Wt. Range KG/12'
1	1879	42.00	31.20	1.50	1.850 - 2.050

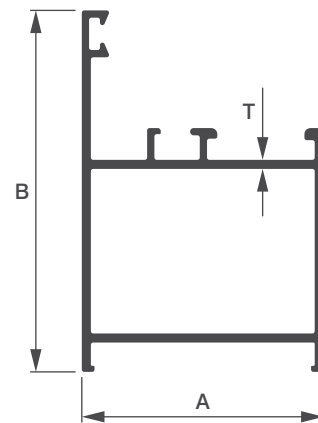

Sl. No.	Sec. No.	A	B	T	Wt. Range KG/12'
1	1882	40.00	59.75	1.50	2.800 - 3.200



CASEMENT WINDOWS

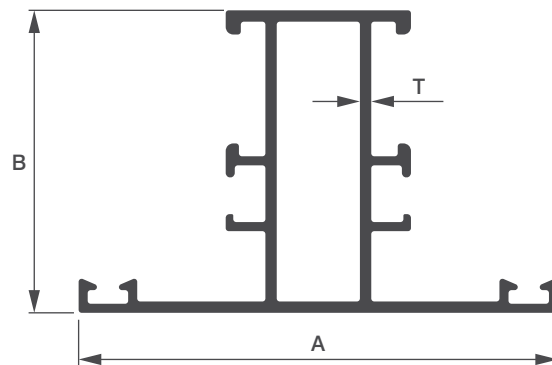

Sl. No.	Sec. No.	A	B	T	Wt. Range KG/12'
1	1883	63.40	40.00	1.50	2.900 - 3.300

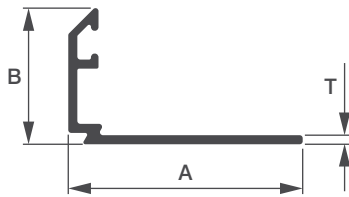

Sl. No.	Sec. No.	A	B	T	Wt. Range KG/12'
1	1898	31.00	18.00	1.20	0.640 - 0.850

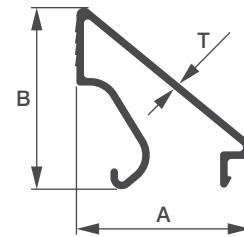

Sl. No.	Sec. No.	A	B	T	Wt. Range KG/12'
1	1886	23.00	24.00	1.00	0.690 - 0.800

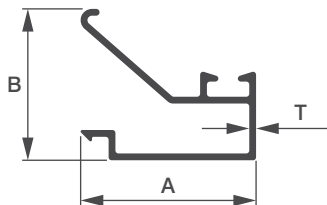

Sl. No.	Sec. No.	A	B	T	Wt. Range KG/12'
1	1885	23.20	20.00	0.90	0.640 - 0.680

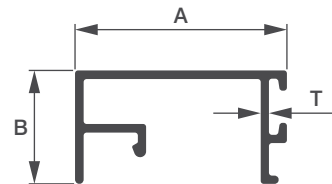

Sl. No.	Sec. No.	A	B	T	Wt. Range KG/12'
1	1887	28.00	15.00	1.09	0.830 - 1.000



CASEMENT WINDOWS



Sl. No.	Sec. No.	A	B	T	Wt. Range KG/12'
1	1888	30.75	9.70	1.10	0.550 - 0.750

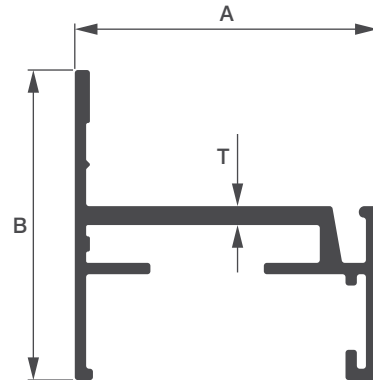

Sl. No.	Sec. No.	A	B	T	Wt. Range KG/12'
1	1889	40.00	41.00	2.50	2.380 - 2.600

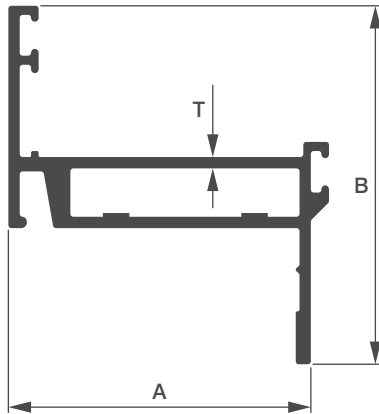

Sl. No.	Sec. No.	A	B	T	Wt. Range KG/12'
1	1890	40.00	47.40	1.50	2.390 - 2.600

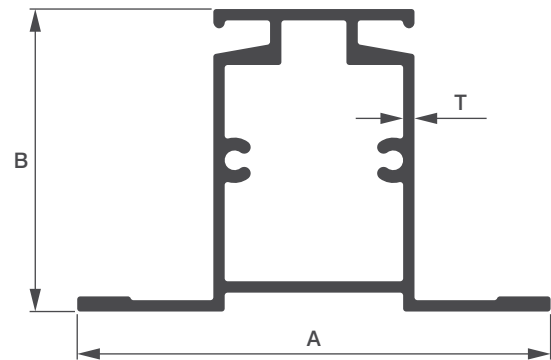

Sl. No.	Sec. No.	A	B	T	Wt. Range KG/12'
1	1891	62.60	40.00	1.50	3.000 - 3.200

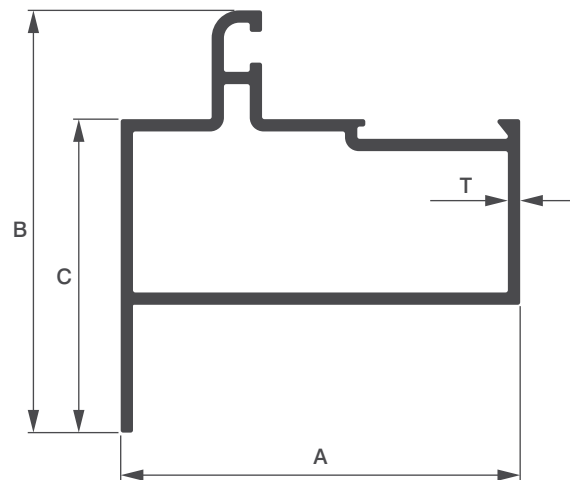

Sl. No.	Sec. No.	A	B	C	T	Wt. Range KG/12'
1	1892	65.00	68.70	51.00	2.00	4.750 - 5.000



CASEMENT WINDOWS

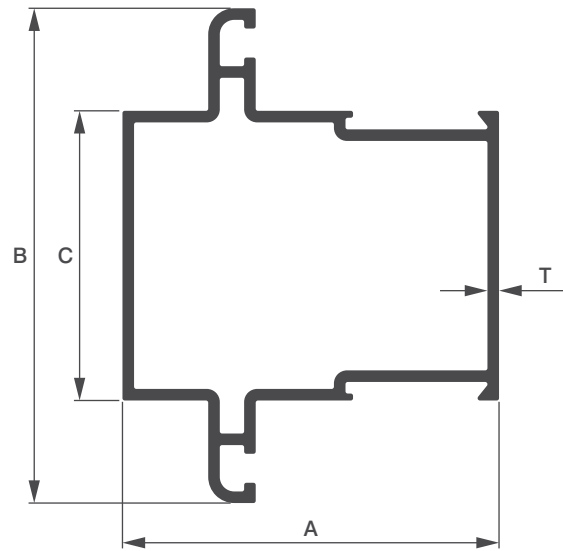

Sl. No.	Sec. No.	A	B	C	T	Wt. Range KG/12'
1	1893	65.00	85.40	50.00	2.00	5.850 - 6.000

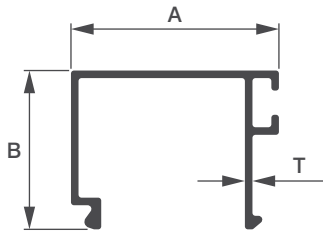

Sl. No.	Sec. No.	A	B	T	Wt. Range KG/12'
1	1894	27.50	21.00	1.00	0.800 - 1.000

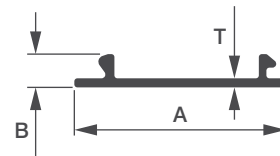

Sl. No.	Sec. No.	A	B	T	Wt. Range KG/12'
1	1895	28.00	4.40	1.20	0.430 - 0.630

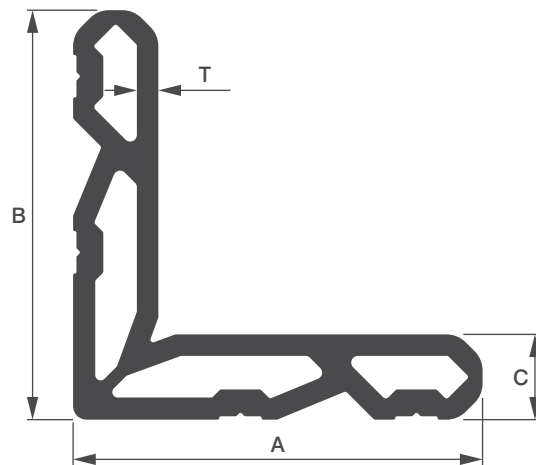

Sl. No.	Sec. No.	A	B	C	T	Wt. Range KG/12'
1	1896	61.00	61.00	12.70	3.20	8.000 - 8.500



CASEMENT WINDOWS

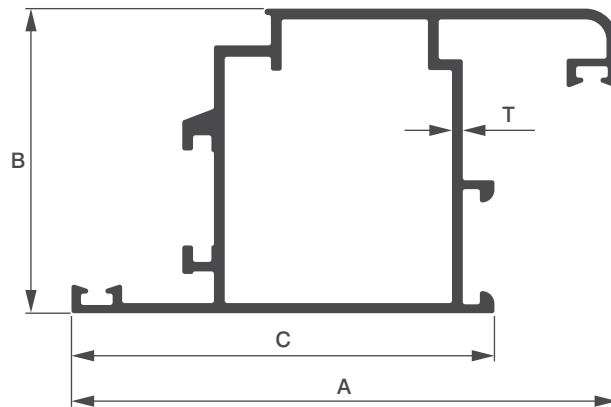

Sl. No.	Sec. No.	A	B	C	T	Wt. Range KG/12'
1	1897	86.20	48.10	66.80	1.70	4.750 - 5.000

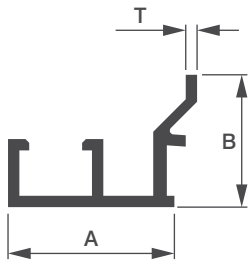

Sl. No.	Sec. No.	A	B	T	Wt. Range KG/12'
1	7581	22.00	17.50	1.50	0.900 - 1.100
2	7586	22.00	18.40	1.50	0.910 - 1.200
3	7590	22.00	18.50	1.50	0.950 - 1.250

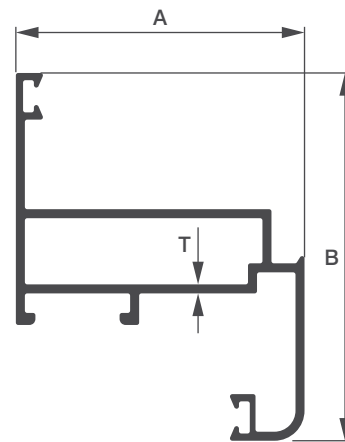

Sl. No.	Sec. No.	A	B	T	Wt. Range KG/12'
1	1884	48.00	61.15	1.50	2.970 - 3.300

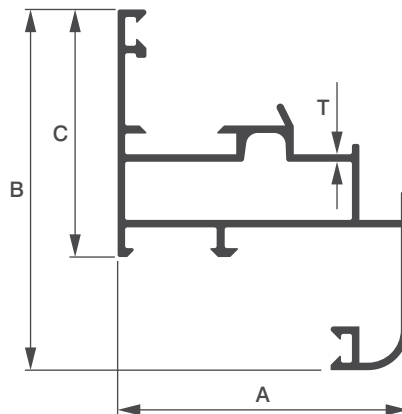

Sl. No.	Sec. No.	A	B	C	T	Wt. Range KG/12'
1	7260	50.50	62.65	43.00	1.30	3.000 - 3.300



CASEMENT WINDOWS

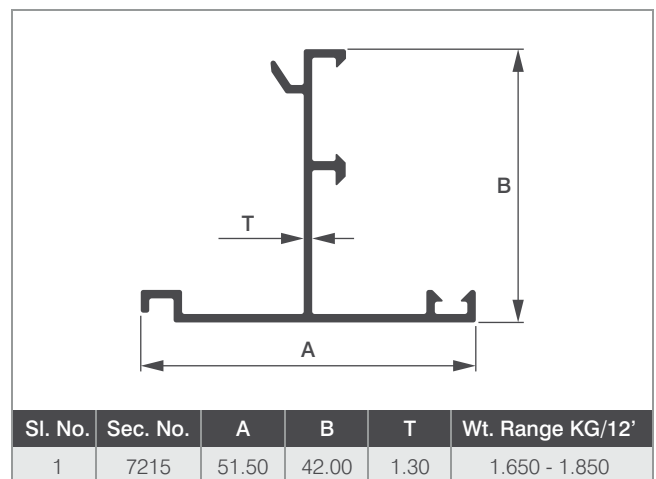
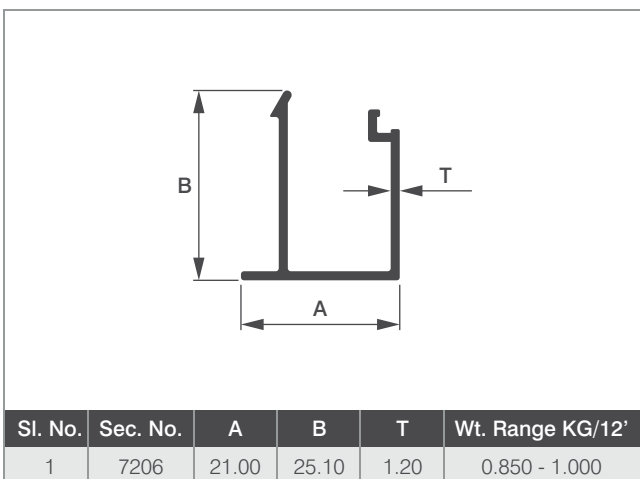
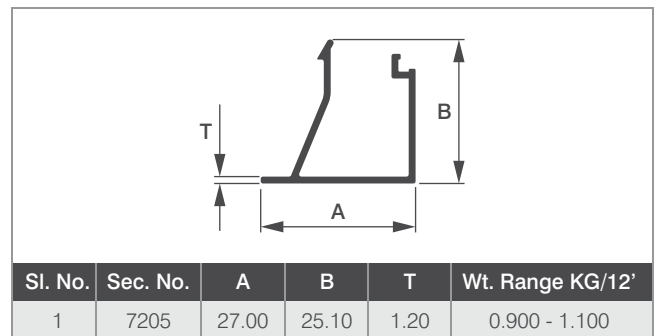
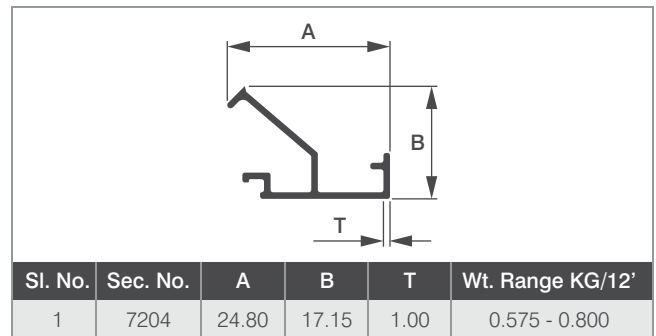
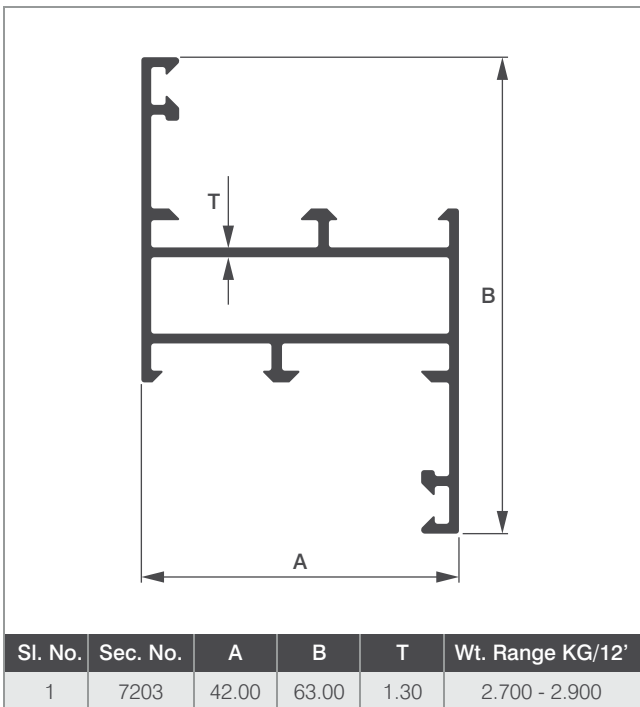
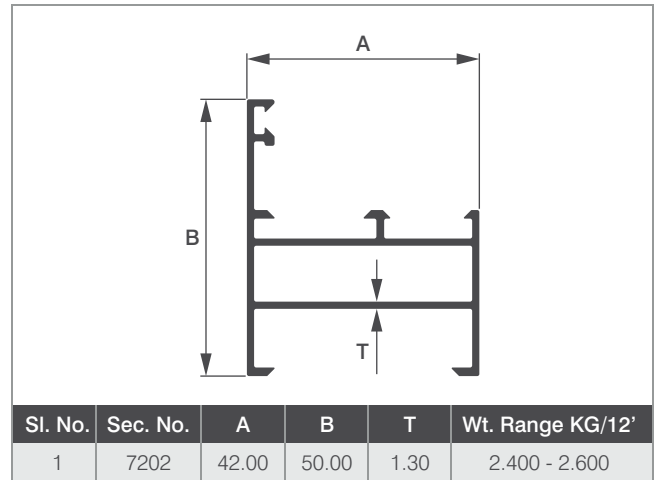
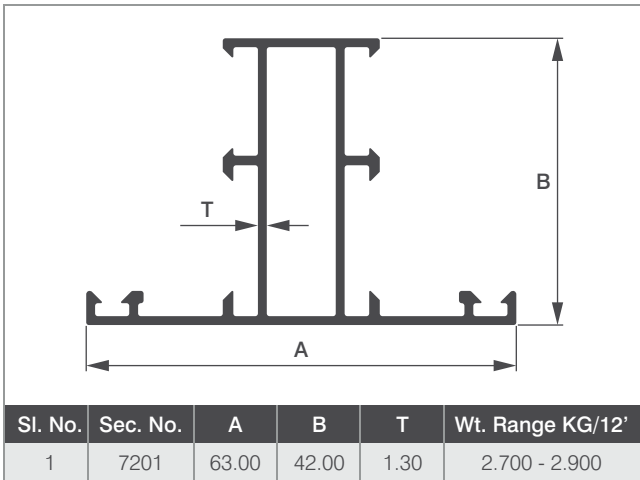



CASEMENT WINDOWS

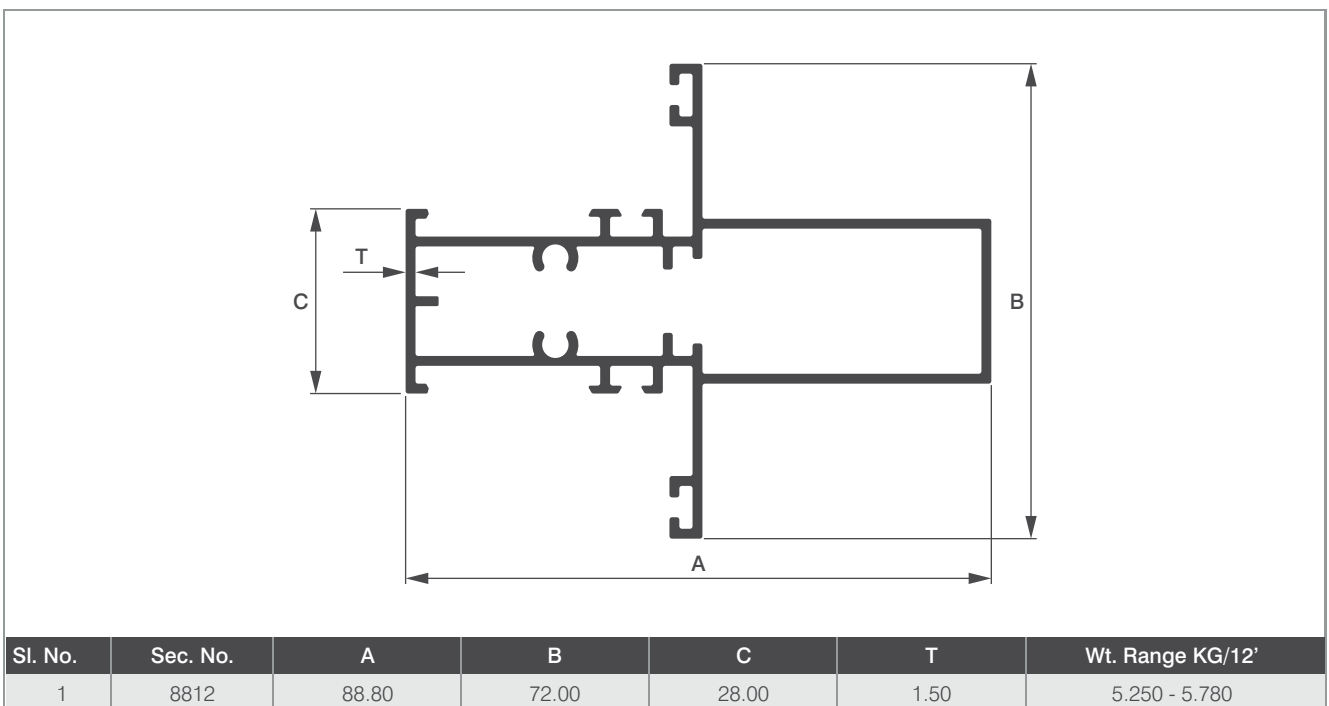
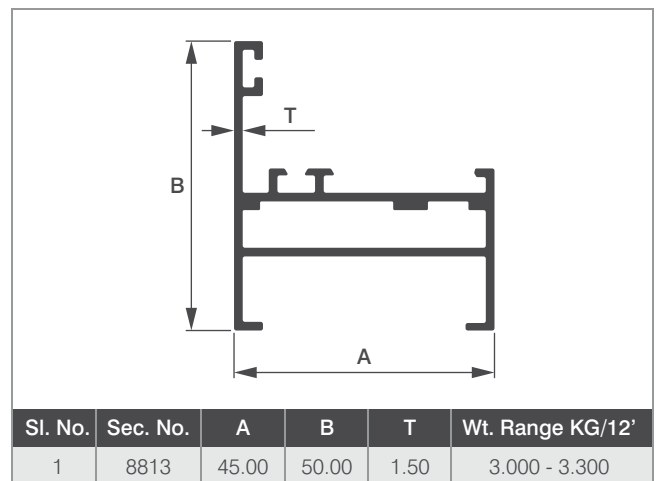
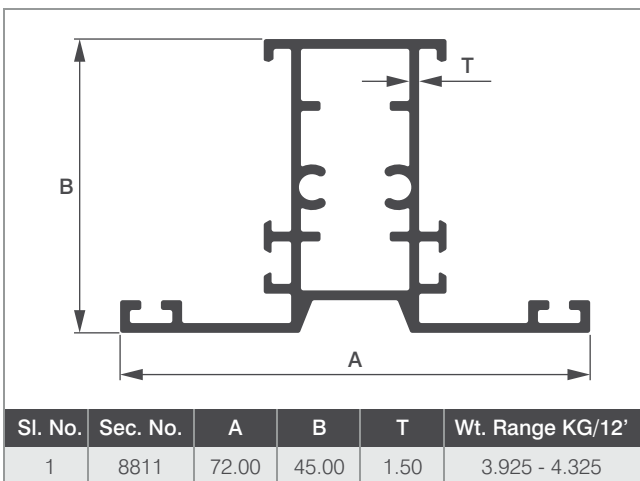
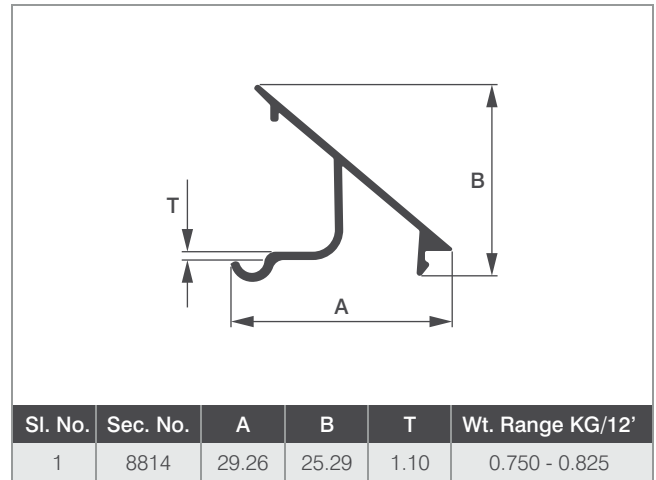
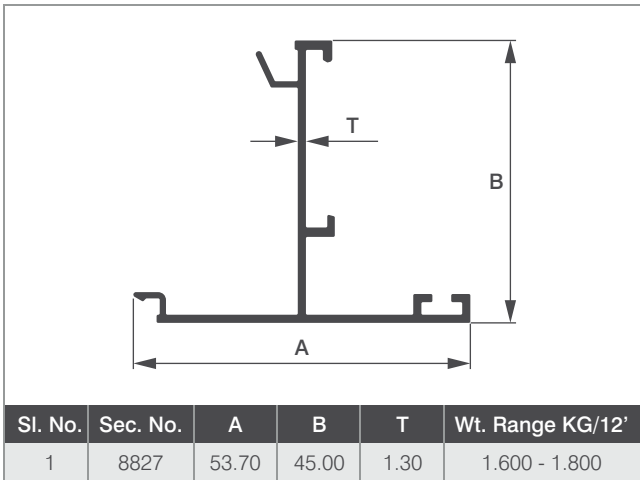



CASEMENT WINDOWS

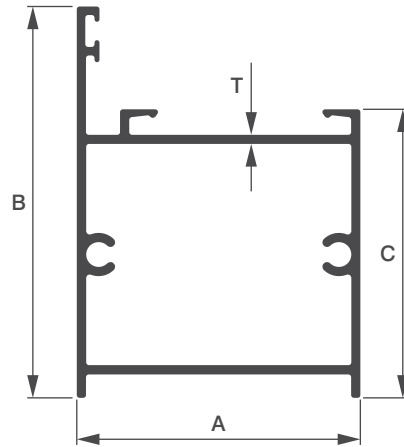

Sl. No.	Sec. No.	A	B	C	T	Wt. Range KG/12'
1	4505	40.00	55.20	40.70	1.30	2.600 - 2.900

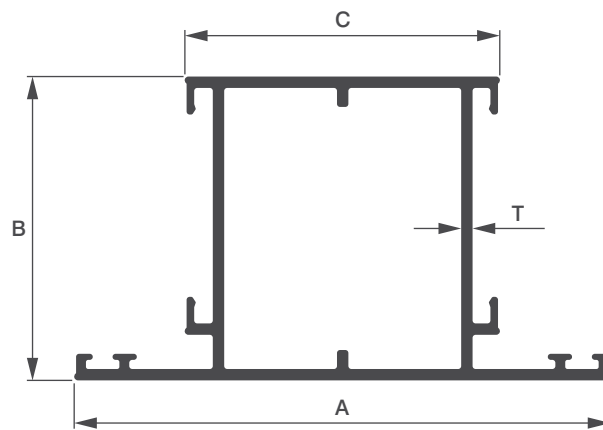

Sl. No.	Sec. No.	A	B	C	T	Wt. Range KG/12'
1	4506	70.60	40.00	41.50	1.50	3.210 - 3.550

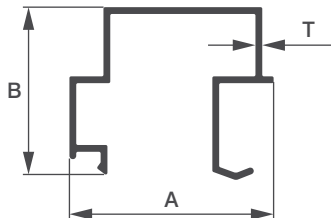

Sl. No.	Sec. No.	A	B	T	Wt. Range KG/12'
1	4507	36.00	29.50	1.20	1.340 - 1.500

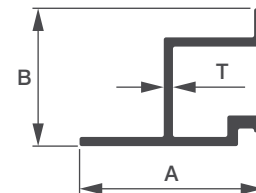

Sl. No.	Sec. No.	A	B	T	Wt. Range KG/12'
1	5117	24.00	18.00	1.20	0.680 - 0.750



CASEMENT WINDOWS

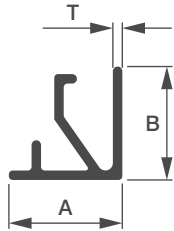

Sl. No.	Sec. No.	A	B	T	Wt. Range KG/12'
1	5308/R	15.00	15.00	1.25	0.600 - 0.660

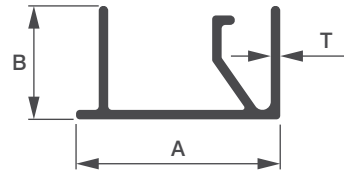

Sl. No.	Sec. No.	A	B	T	Wt. Range KG/12'
1	5314	27.00	15.00	1.25	0.860 - 0.940

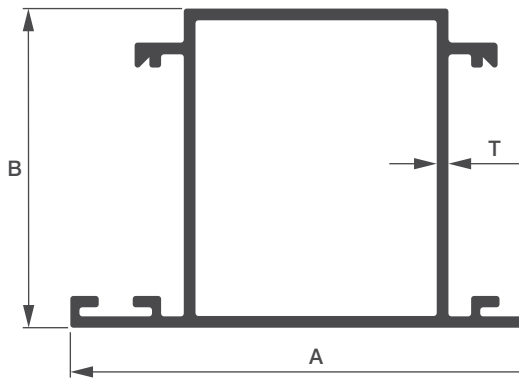

Sl. No.	Sec. No.	A	B	T	Wt. Range KG/12'
1	5316	65.00	42.20	1.55	3.200 - 3.500

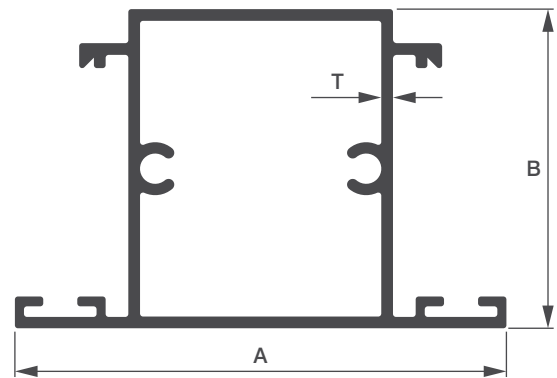

Sl. No.	Sec. No.	A	B	T	Wt. Range KG/12'
1	5353	65.00	42.20	1.55	3.600 - 3.900

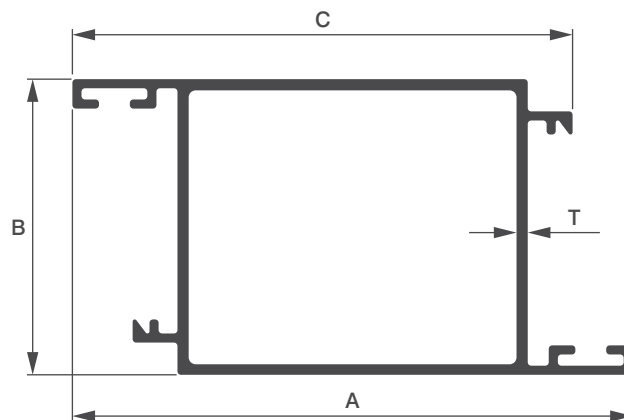

Sl. No.	Sec. No.	A	B	C	T	Wt. Range KG/12'
1	5317	80.00	42.20	71.40	1.60	3.700 - 4.000



CASEMENT WINDOWS

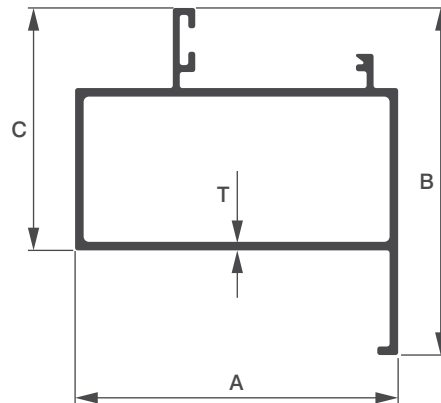

Sl. No.	Sec. No.	A	B	C	T	Wt. Range KG/12'
1	5352	60.50	65.00	45.40	1.60	3.550 - 3.900

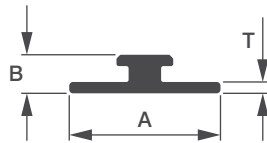

Sl. No.	Sec. No.	A	B	T	Wt. Range KG/12'
1	5307	20.00	5.10	1.50	0.490 - 0.520

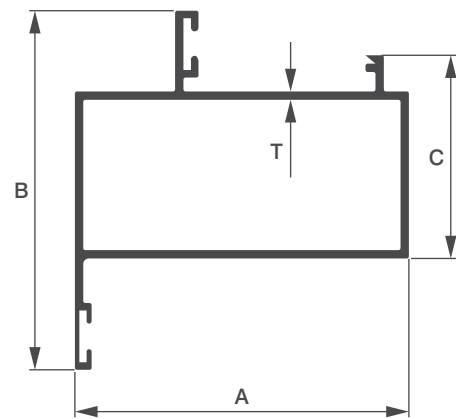

Sl. No.	Sec. No.	A	B	C	T	Wt. Range KG/12'
1	5349	60.00	64.50	36.50	1.50	3.300 - 3.600

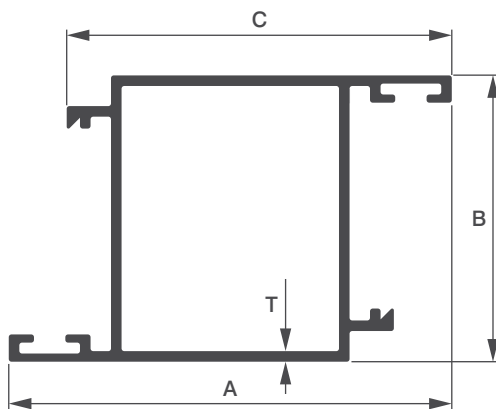

Sl. No.	Sec. No.	A	B	C	T	Wt. Range KG/12'
1	5357	65.00	42.00	56.50	1.55	3.200 - 3.800

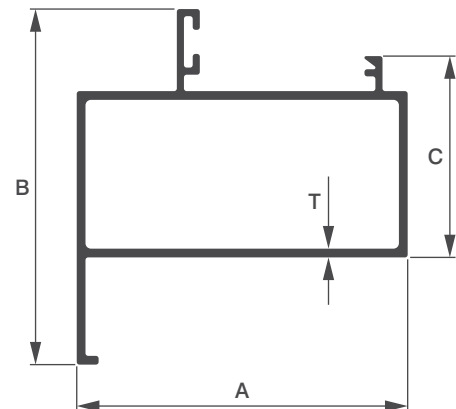

Sl. No.	Sec. No.	A	B	C	T	Wt. Range KG/12'
1	5309	60.50	65.00	36.80	1.60	3.600 - 4.000



CASEMENT WINDOWS

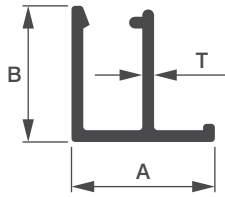

Sl. No.	Sec. No.	A	B	T	Wt. Range KG/12'
1	5334	15.80	15.00	1.30	0.570 - 0.630

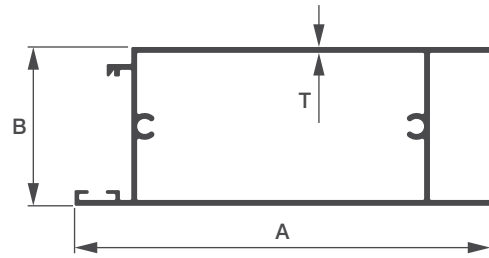

Sl. No.	Sec. No.	A	B	T	Wt. Range KG/12'
1	5335	110.00	42.00	1.55	4.800 - 5.200

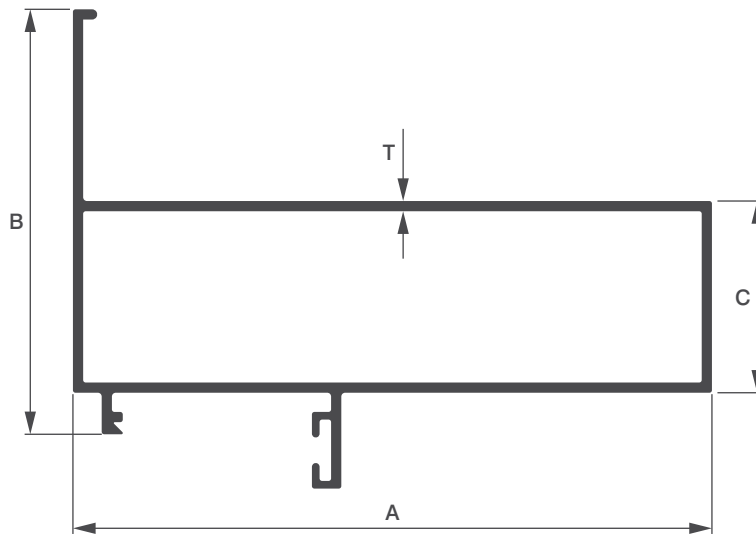

Sl. No.	Sec. No.	A	B	C	T	Wt. Range KG/12'
1	5350	100.00	66.50	30.00	1.60	5.000 - 5.400

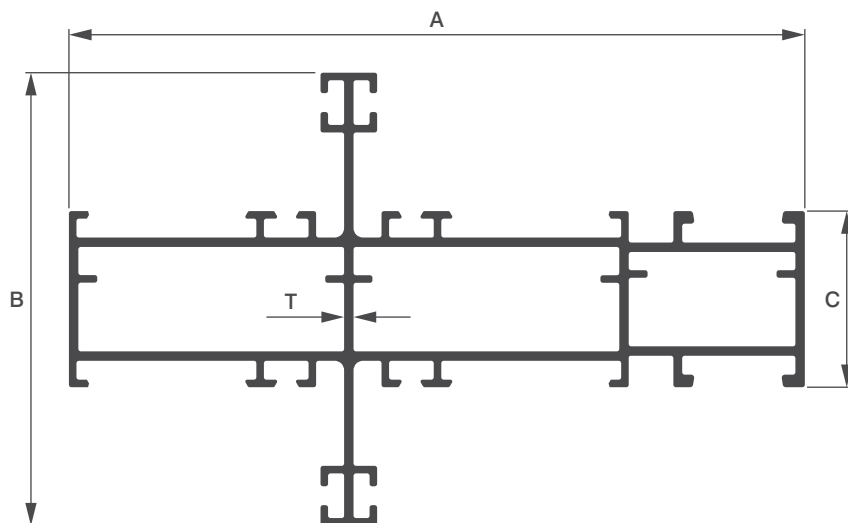

Sl. No.	Sec. No.	A	B	C	T	Wt. Range KG/12'
1	8885	117.00	72.00	28.00	1.50	7.350 - 7.750



CASEMENT WINDOWS

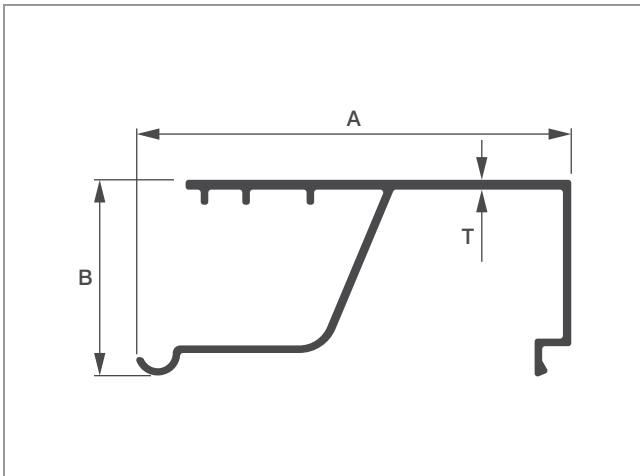

Sl. No.	Sec. No.	A	B	T	Wt. Range KG/12'
1	8886	57.50	25.90	1.30	1.500 - 1.750

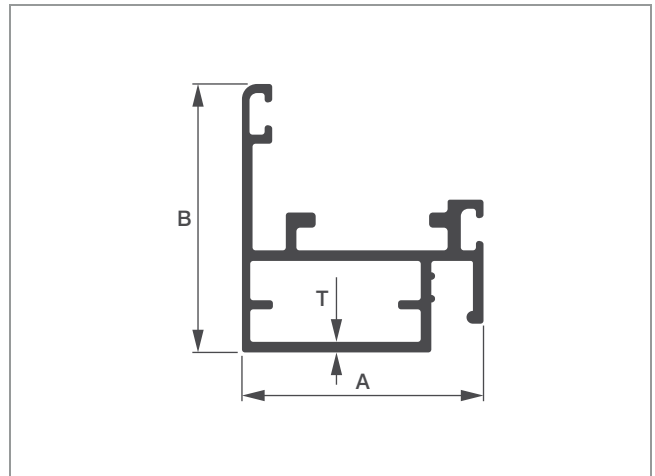

Sl. No.	Sec. No.	A	B	T	Wt. Range KG/12'
1	8887	31.94	35.50	1.40	1.950 - 2.250

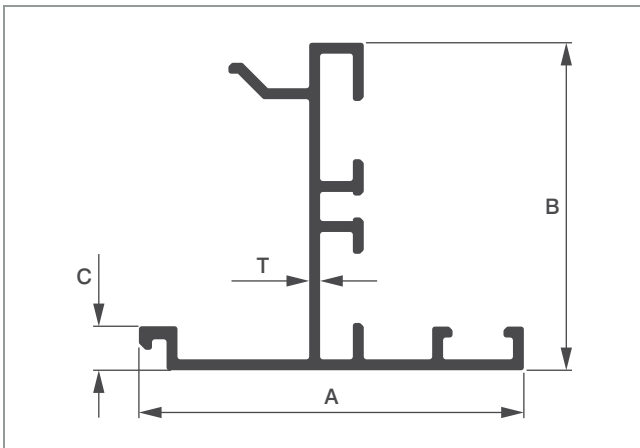

Sl. No.	Sec. No.	A	B	C	T	Wt. Range KG/12'
1	7584	52.90	45.00	6.00	1.50	2.400 - 2.750

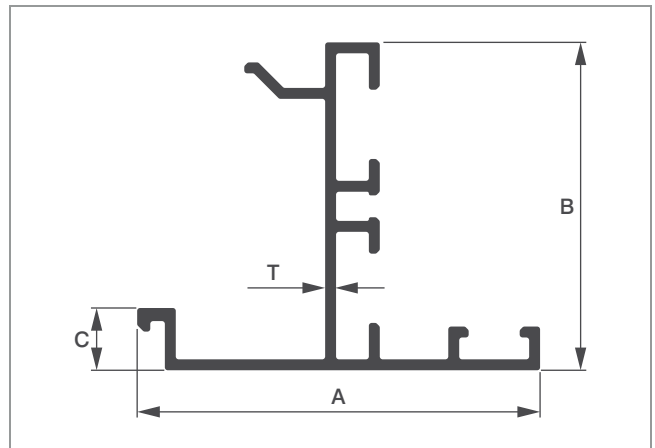

Sl. No.	Sec. No.	A	B	C	T	Wt. Range KG/12'
1	7356/R	55.30	45.00	8.55	1.50	2.450 - 2.800

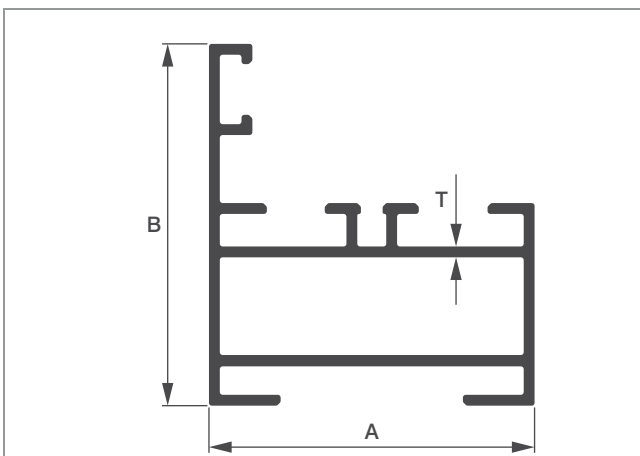

Sl. No.	Sec. No.	A	B	T	Wt. Range KG/12'
1	7355	45.00	50.00	1.50	3.400 - 3.700

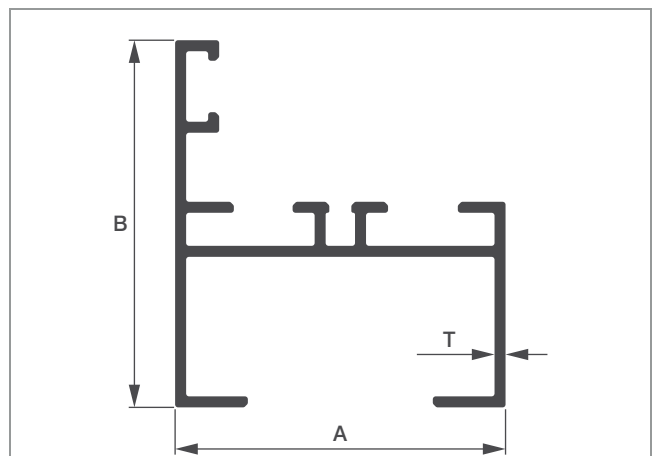

Sl. No.	Sec. No.	A	B	T	Wt. Range KG/12'
1	7357	45.00	50.00	1.50	2.600 - 2.800



CASEMENT WINDOWS

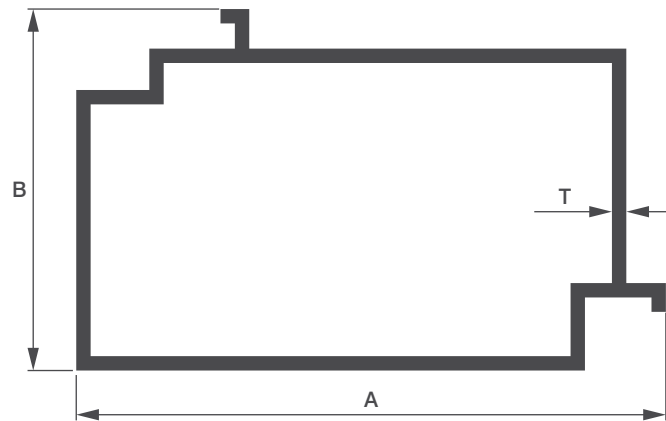

Sl. No.	Sec. No.	A	B	T	Wt. Range KG/12'
1	7369	81.97	50.25	2.00	4.800 - 5.200

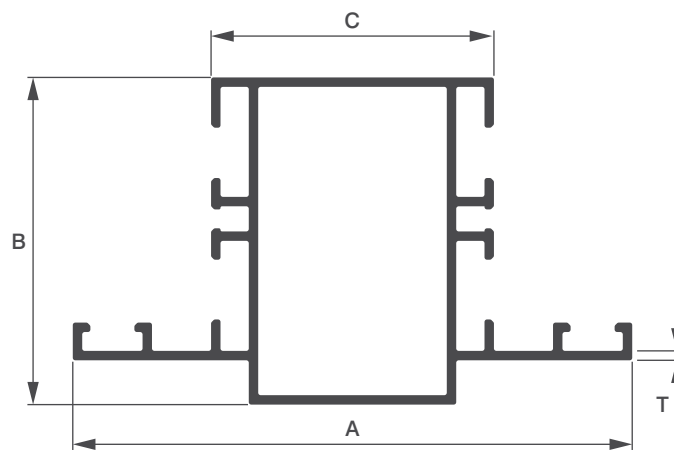

Sl. No.	Sec. No.	A	B	C	T	Wt. Range KG/12'
1	7358	89.00	52.05	45.00	1.50	4.600 - 5.000

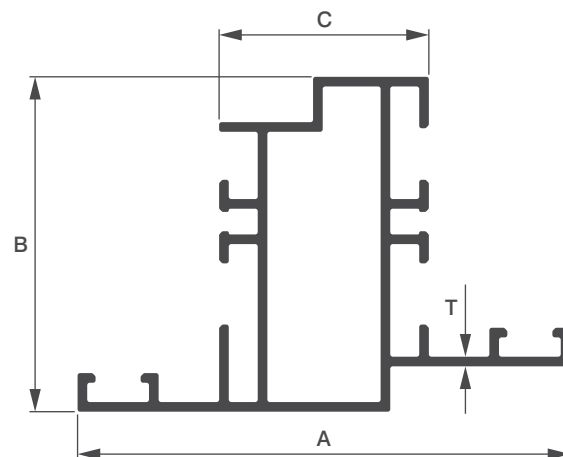

Sl. No.	Sec. No.	A	B	C	T	Wt. Range KG/12'
1	7359	76.60	52.05	32.60	1.50	4.300 - 4.700



CASEMENT WINDOWS

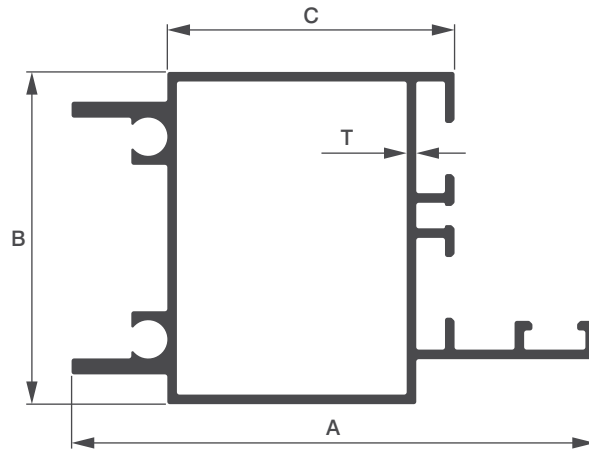

Sl. No.	Sec. No.	A	B	C	T	Wt. Range KG/12'
1	7360	82.00	52.05	45.00	1.50	4.700 - 5.100

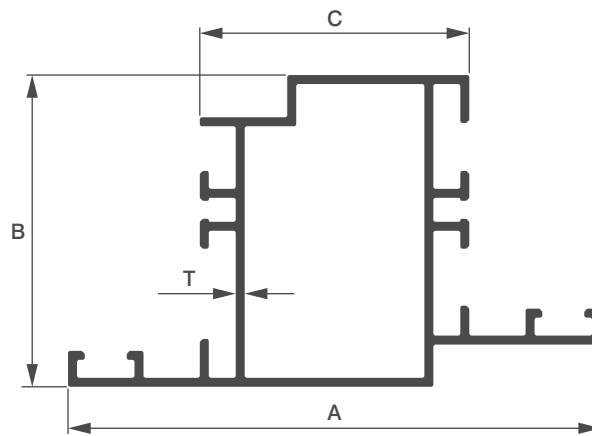

Sl. No.	Sec. No.	A	B	C	T	Wt. Range KG/12'
1	7361	89.00	52.05	45.00	1.50	4.600 - 5.000

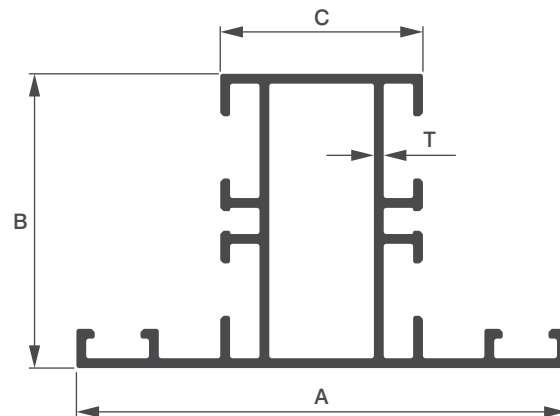

Sl. No.	Sec. No.	A	B	C	T	Wt. Range KG/12'
1	7363	75.00	45.00	31.00	1.50	4.000 - 4.400



CASEMENT WINDOWS

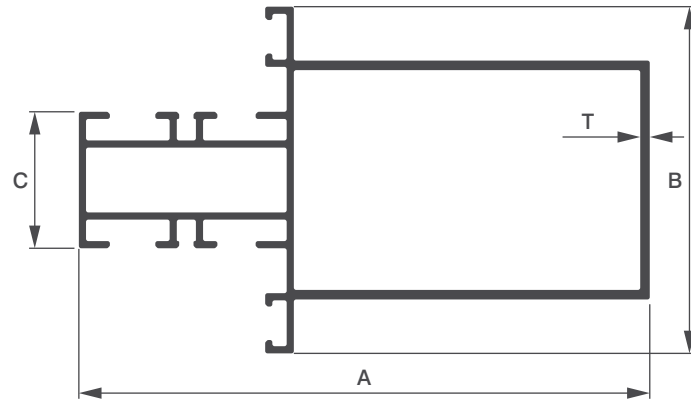

Sl. No.	Sec. No.	A	B	C	T	Wt. Range KG/12'
1	7362	119.50	72.57	28.57	2.00	7.800 - 8.200

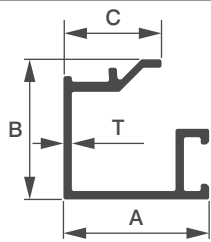

Sl. No.	Sec. No.	A	B	C	T	Wt. Range KG/12'
1	7364	26.00	25.00	17.50	1.50	1.250 - 1.400

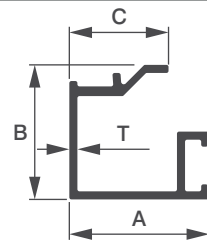

Sl. No.	Sec. No.	A	B	C	T	Wt. Range KG/12'
1	7587	26.00	25.00	18.43	1.50	1.250 - 1.450

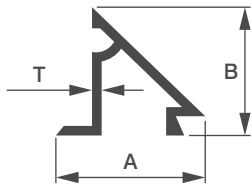

Sl. No.	Sec. No.	A	B	T	Wt. Range KG/12'
1	7286	19.75	16.97	1.27	0.550 - 0.600

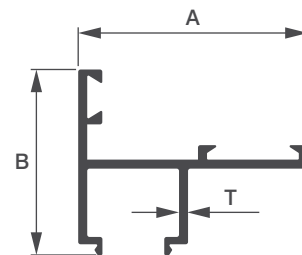

Sl. No.	Sec. No.	A	B	T	Wt. Range KG/12'
1	7589	38.12	30.80	1.50	1.400 - 1.700

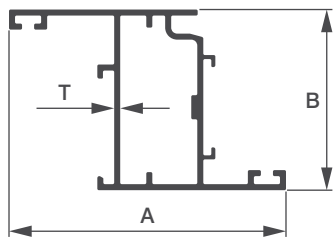

Sl. No.	Sec. No.	A	B	T	Wt. Range KG/12'
1	7227	51.75	45.00	1.50	3.400 - 3.700

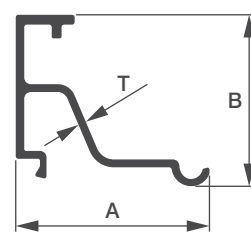

Sl. No.	Sec. No.	A	B	T	Wt. Range KG/12'
1	7228	29.60	26.20	1.20	0.900 - 1.000



CASEMENT WINDOWS

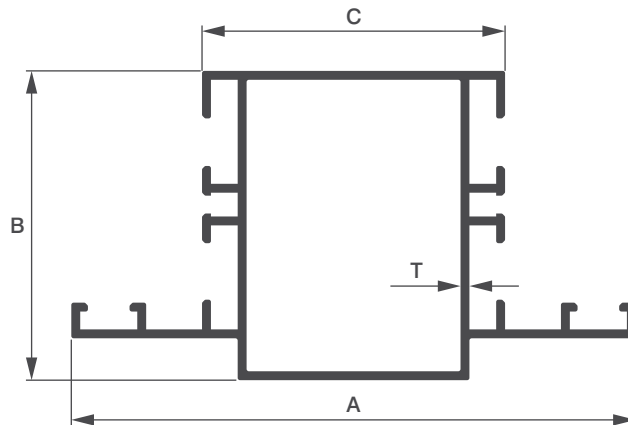

Sl. No.	Sec. No.	A	B	C	T	Wt. Range KG/12'
1	7370	95.00	52.05	51.00	1.50	4.800 - 5.200

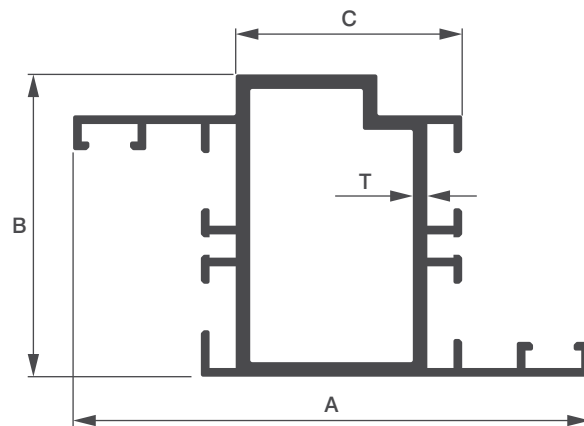

Sl. No.	Sec. No.	A	B	C	T	Wt. Range KG/12'
1	7371	89.00	52.05	39.00	2.50	6.100 - 6.500

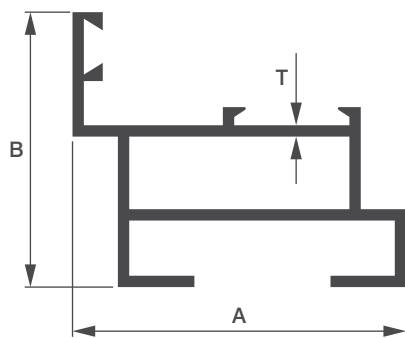

Sl. No.	Sec. No.	A	B	T	Wt. Range KG/12'
1	7373	44.12	36.35	1.50	2.300 - 2.500

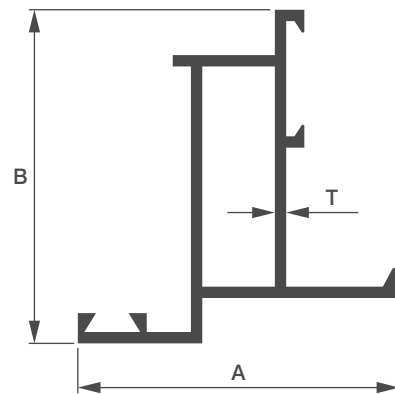

Sl. No.	Sec. No.	A	B	T	Wt. Range KG/12'
1	7374	42.50	44.12	1.50	2.050 - 2.250



CASEMENT WINDOWS

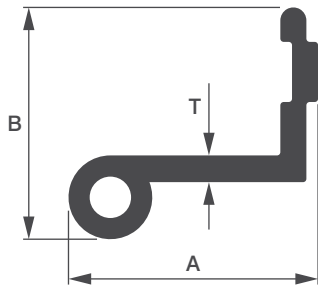

Sl. No.	Sec. No.	A	B	T	Wt. Range KG/12'
1	7281	37.37	34.70	4.00	2.700 - 2.900

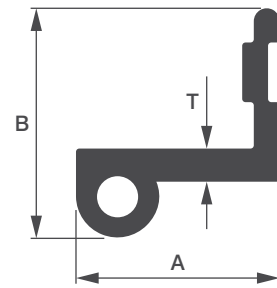

Sl. No.	Sec. No.	A	B	T	Wt. Range KG/12'
1	7282	30.72	34.70	5.00	2.850 - 3.050

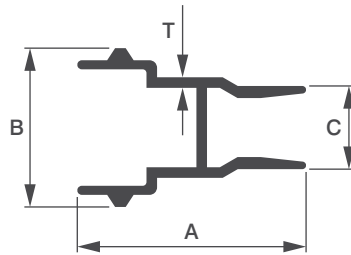

Sl. No.	Sec. No.	A	B	C	T	Wt. Range KG/12'
1	7283	30.25	21.00	11.00	1.40	1.050 - 1.150

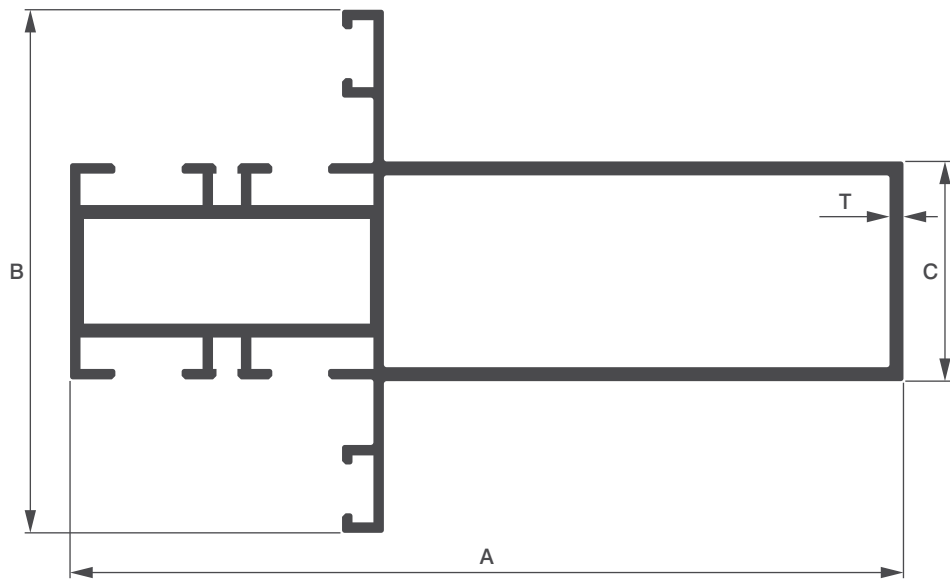

Sl. No.	Sec. No.	A	B	C	T	Wt. Range KG/12'
1	7285	119.50	75.00	31.50	2.00	7.500 - 7.900



CASEMENT WINDOWS

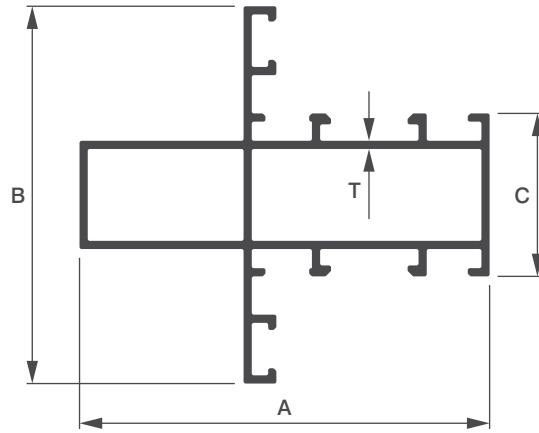

Sl. No.	Sec. No.	A	B	C	T	Wt. Range KG/12'
1	7582	75.00	69.00	29.80	1.50	4.750 - 5.350

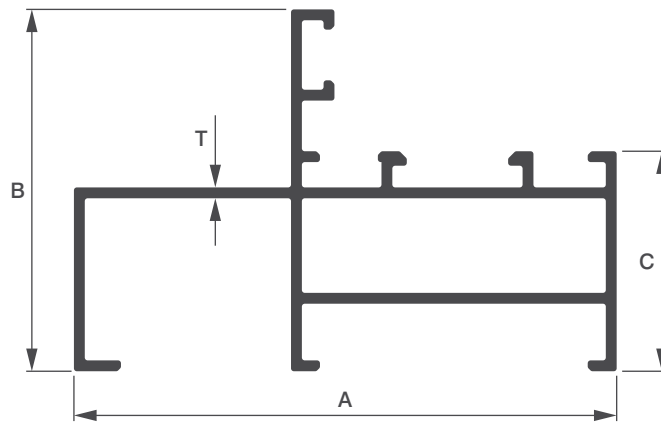

Sl. No.	Sec. No.	A	B	C	T	Wt. Range KG/12'
1	7583	75.00	50.00	30.40	1.50	3.800 - 4.400

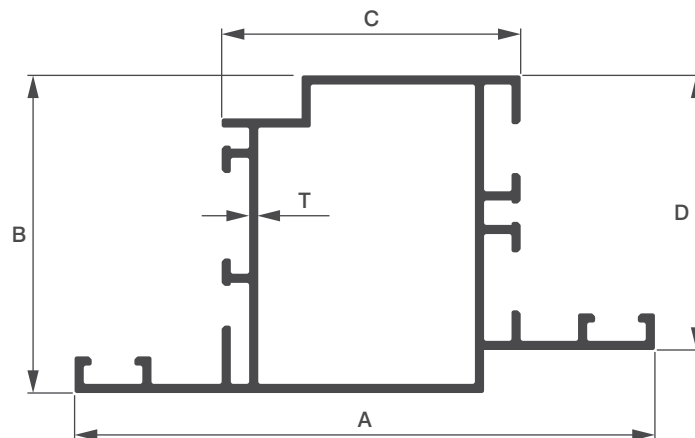

Sl. No.	Sec. No.	A	B	C	D	T	Wt. Range KG/12'
1	7585	95.10	52.00	49.00	45.00	1.50	4.700 - 5.300



CASEMENT WINDOWS

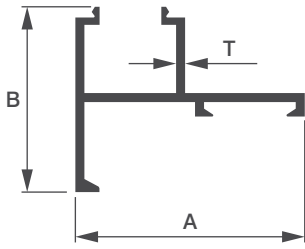

Sl. No.	Sec. No.	A	B	T	Wt. Range KG/12'
1	7375	38.12	30.80	1.50	1.350 - 1.500

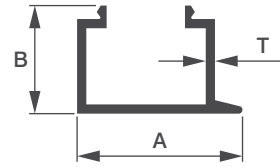

Sl. No.	Sec. No.	A	B	T	Wt. Range KG/12'
1	7376	21.88	14.30	1.22	0.640 - 0.700

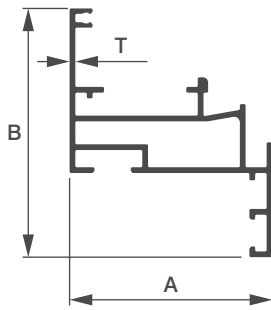

Sl. No.	Sec. No.	A	B	T	Wt. Range KG/12'
1	7605	53.00	65.00	1.50	2.600 - 2.800

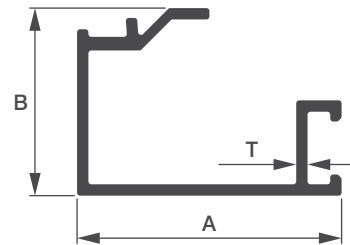

Sl. No.	Sec. No.	A	B	T	Wt. Range KG/12'
1	7607	35.00	24.80	1.50	1.400 - 1.550

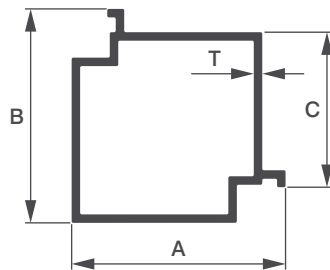

Sl. No.	Sec. No.	A	B	C	T	Wt. Range KG/12'
1	7372	50.50	50.50	36.60	2.00	3.700 - 4.000

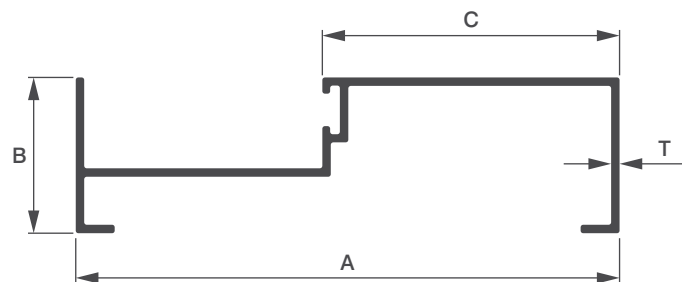

Sl. No.	Sec. No.	A	B	C	T	Wt. Range KG/12'
1	8844	83.80	24.00	45.80	1.30	2.000 - 2.200



CASEMENT WINDOWS

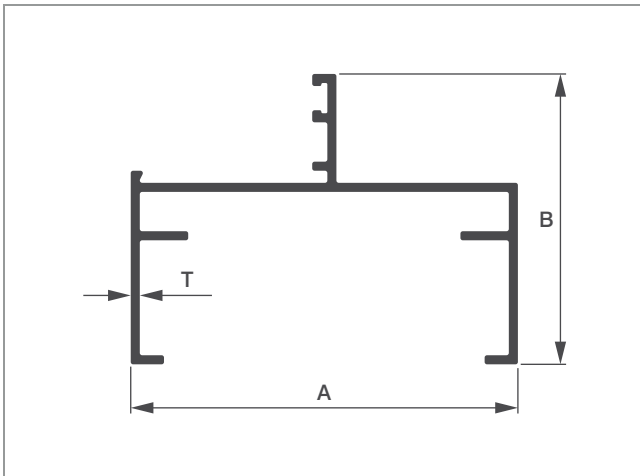

Sl. No.	Sec. No.	A	B	T	Wt. Range KG/12'
1	8828	64.00	48.00	1.50	2.500 - 2.700

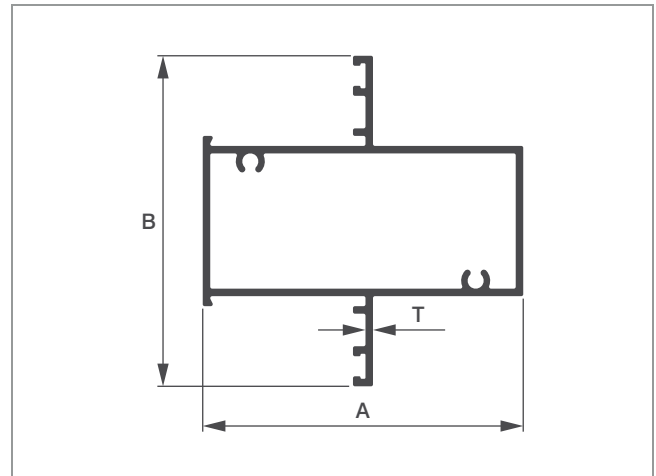

Sl. No.	Sec. No.	A	B	T	Wt. Range KG/12'
1	8829	64.00	66.00	1.50	3.700 - 4.000

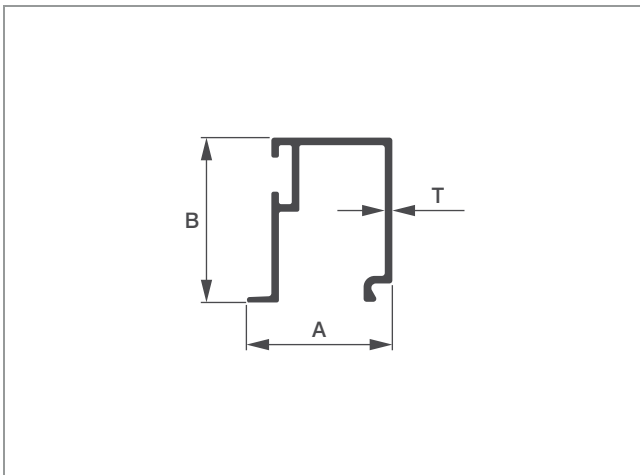

Sl. No.	Sec. No.	A	B	T	Wt. Range KG/12'
1	8826	19.30	21.80	1.00	0.650 - 0.725

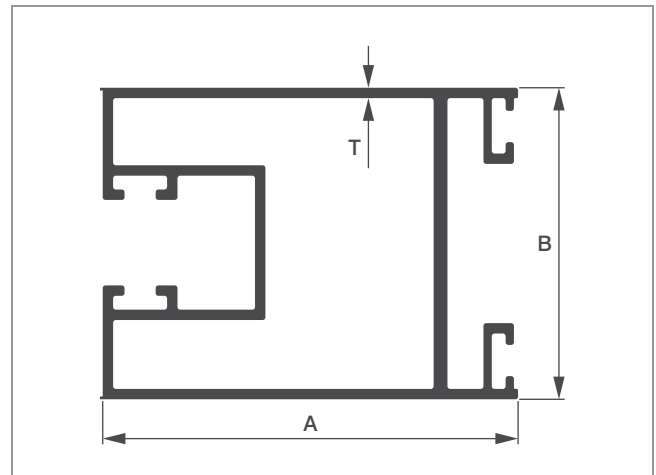

Sl. No.	Sec. No.	A	B	T	Wt. Range KG/12'
1	8824	60.00	45.00	1.50	4.550 - 4.800

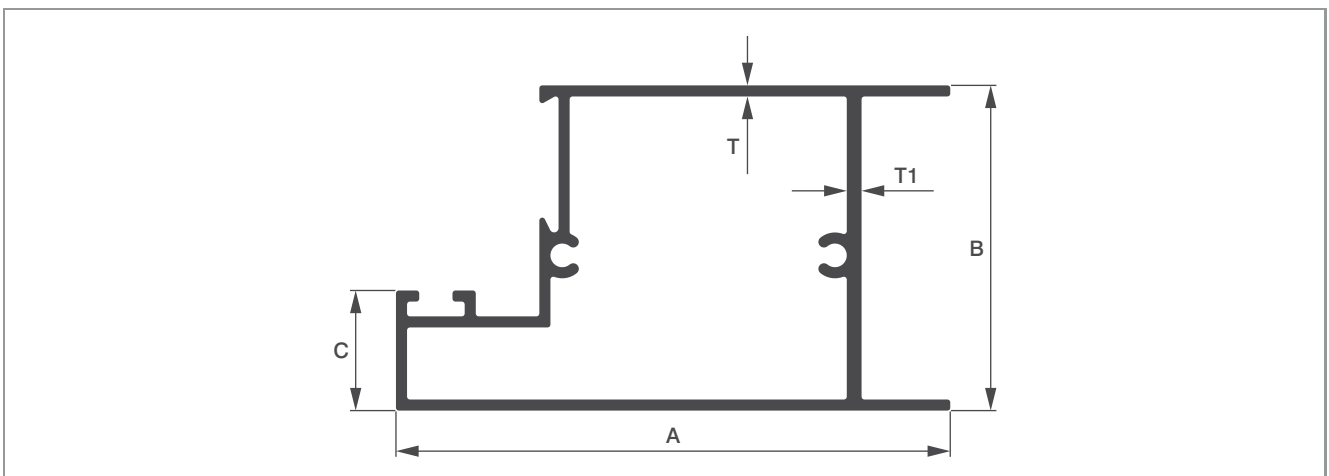

Sl. No.	Sec. No.	A	B	C	T	T1	Wt. Range KG/12'
1	8825	75.00	44.00	16.25	1.50	2.00	4.050 - 4.400



CASEMENT WINDOWS

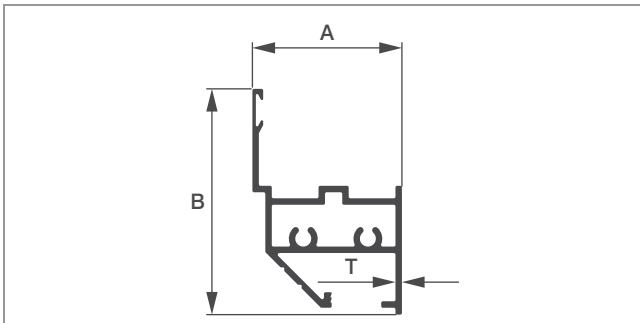

Sl. No.	Sec. No.	A	B	T	Wt. Range KG/12'
1	8850	34.70	52.40	1.50	2.600 - 2.800

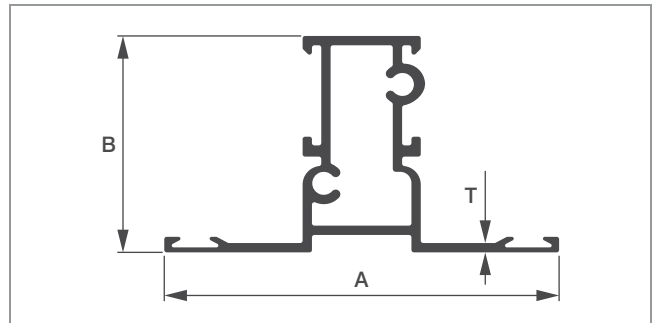

Sl. No.	Sec. No.	A	B	T	Wt. Range KG/12'
1	8851	63.50	34.80	1.50	2.550 - 2.800

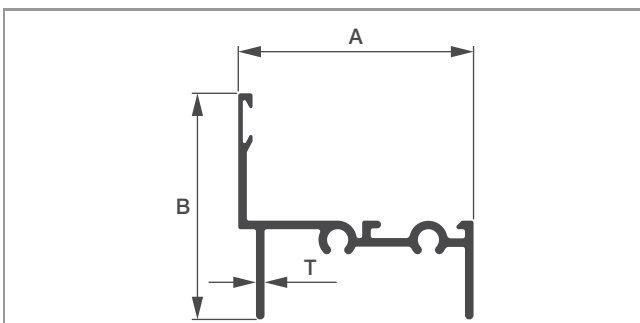

Sl. No.	Sec. No.	A	B	T	Wt. Range KG/12'
1	8849	41.20	39.60	1.50	1.700 - 1.900

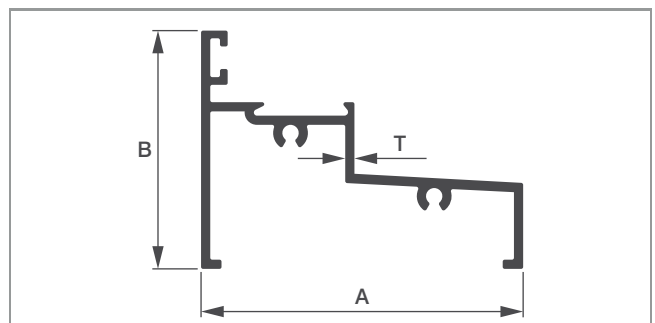

Sl. No.	Sec. No.	A	B	T	Wt. Range KG/12'
1	8854	63.00	46.60	1.80	3.000 - 3.300

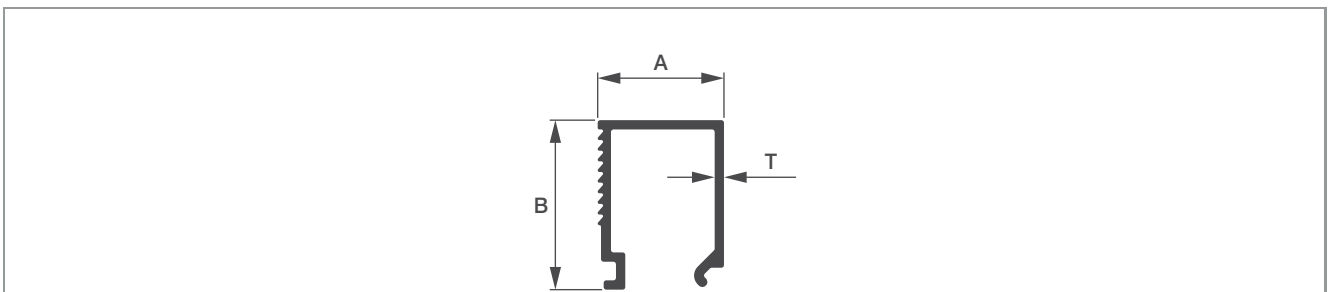

Sl. No.	Sec. No.	A	B	T	Wt. Range KG/12'
1	8852	19.00	25.50	1.40	1.050 - 1.200

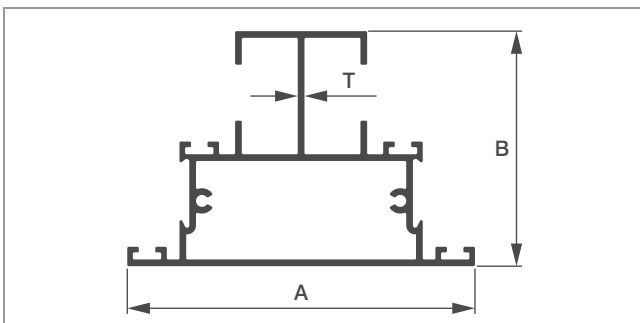

Sl. No.	Sec. No.	A	B	T	Wt. Range KG/12'
1	8856	93.20	63.00	1.80	6.400 - 6.800

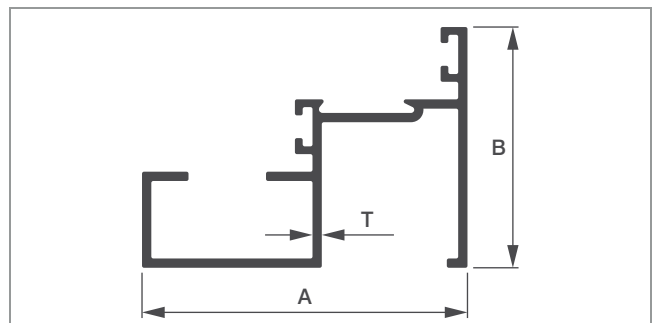

Sl. No.	Sec. No.	A	B	T	Wt. Range KG/12'
1	8855	63.00	46.60	1.80	3.400 - 3.700



CASEMENT WINDOWS

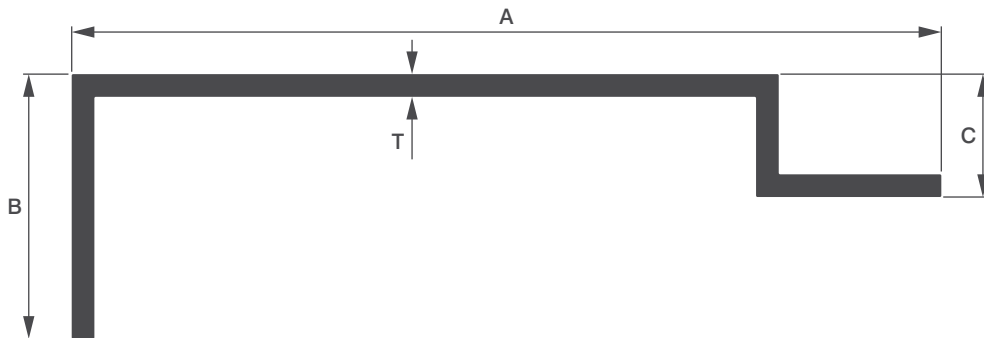

Sl. No.	Sec. No.	A	B	C	T	Wt. Range KG/12'
1	5519	115.00	35.00	16.20	3.00	4.700 - 5.200

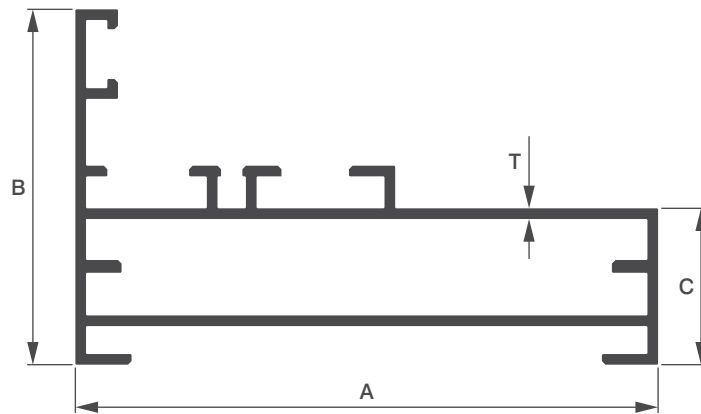

Sl. No.	Sec. No.	A	B	C	T	Wt. Range KG/12'
1	5521	82.00	50.00	22.00	1.50	4.400 - 5.100

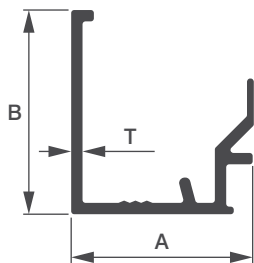

Sl. No.	Sec. No.	A	B	T	Wt. Range KG/12'
1	5522	24.00	27.00	1.50	0.950 - 1.350

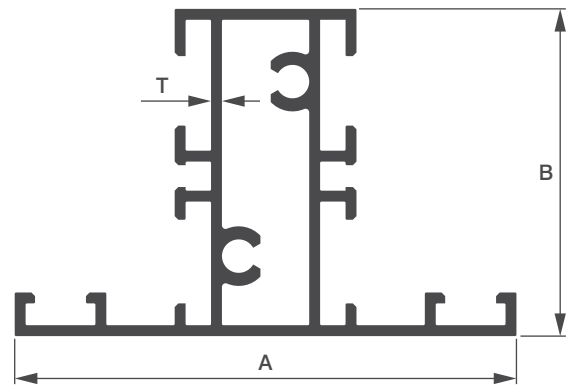

Sl. No.	Sec. No.	A	B	T	Wt. Range KG/12'
1	5523	69.00	45.00	1.50	4.100 - 4.700



CASEMENT WINDOWS

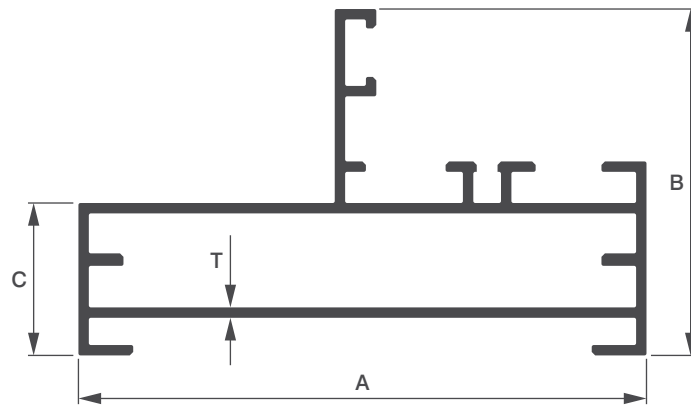

Sl. No.	Sec. No.	A	B	C	T	Wt. Range KG/12'
1	5524	82.00	50.00	22.00	1.50	4.400 - 4.900

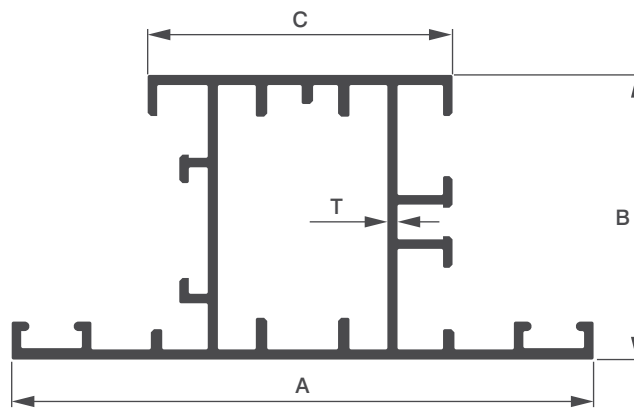

Sl. No.	Sec. No.	A	B	C	T	Wt. Range KG/12'
1	5525	92.00	45.00	48.20	1.60	5.100 - 5.800

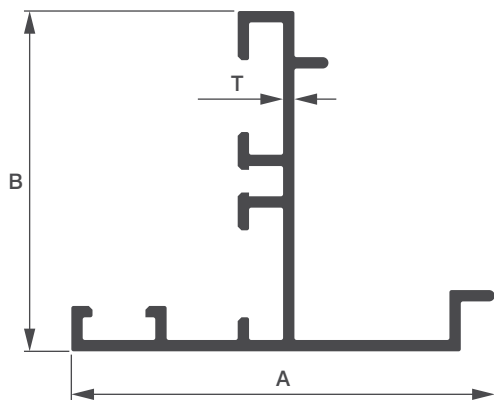

Sl. No.	Sec. No.	A	B	T	Wt. Range KG/12'
1	5526	56.00	45.00	1.50	2.200 - 2.800

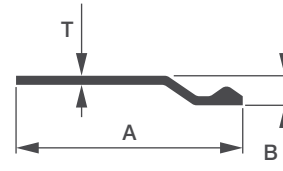

Sl. No.	Sec. No.	A	B	T	Wt. Range KG/12'
1	5529	30.00	3.90	1.20	0.350 - 0.750



CASEMENT WINDOWS

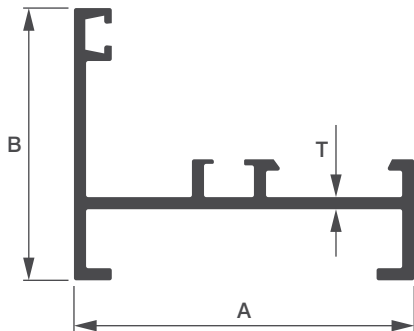

Sl. No.	Sec. No.	A	B	T	Wt. Range KG/12'
1	5573	45.00	36.00	1.60	1.950 - 2.550

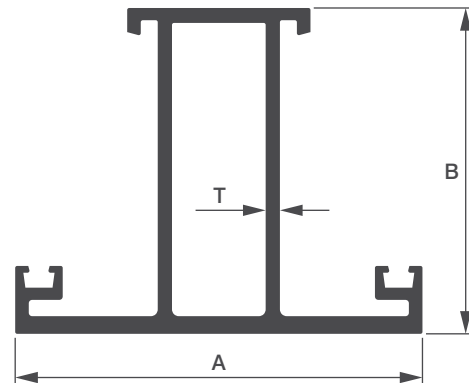

Sl. No.	Sec. No.	A	B	T	Wt. Range KG/12'
1	5574	60.00	48.00	2.10	4.500 - 5.300

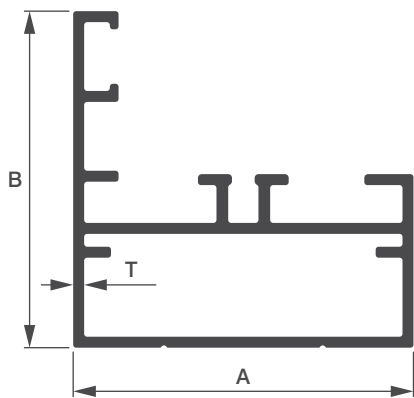

Sl. No.	Sec. No.	A	B	T	Wt. Range KG/12'
1	5589	45.00	44.50	1.45	2.800 - 3.400

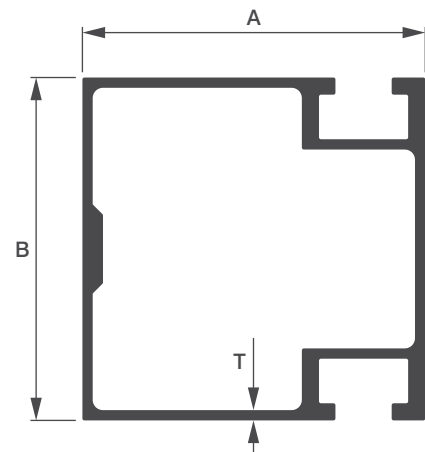

Sl. No.	Sec. No.	A	B	T	Wt. Range KG/12'
1	5590	50.00	50.00	1.50	3.900 - 4.500

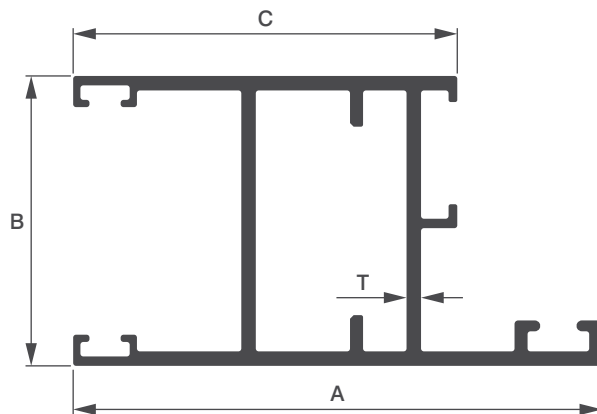

Sl. No.	Sec. No.	A	B	C	T	Wt. Range KG/12'
1	5598	73.00	40.00	53.00	2.00	4.400 - 4.700



CASEMENT WINDOWS

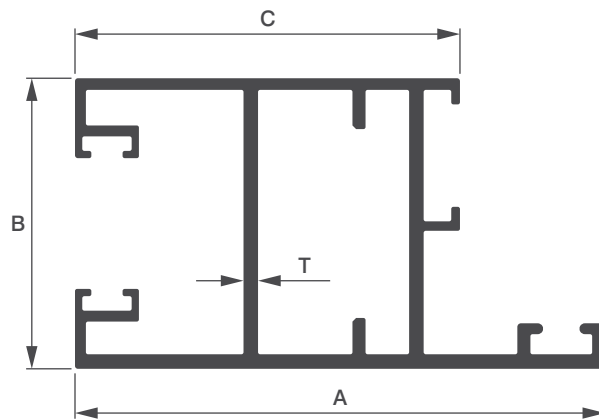

Sl. No.	Sec. No.	A	B	C	T	Wt. Range KG/12'
1	5599	73.00	40.00	53.00	2.00	4.750 - 5.150

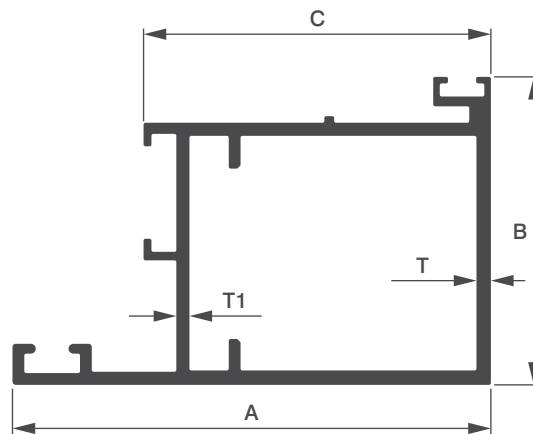

Sl. No.	Sec. No.	A	B	C	T	T1	Wt. Range KG/12'
1	5600	73.00	47.00	53.00	2.00	2.20	4.800 - 5.200

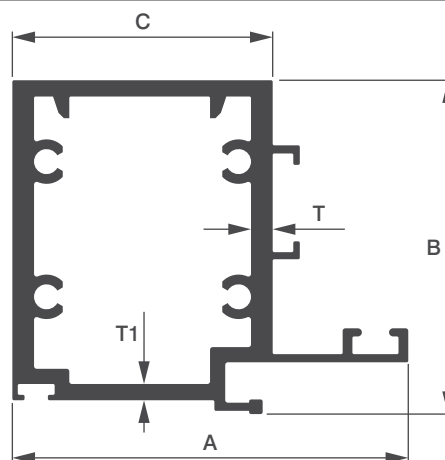

Sl. No.	Sec. No.	A	B	C	T	T1	Wt. Range KG/12'
1	5608	73.00	61.50	48.00	4.00	3.00	8.900 - 9.400



CASEMENT WINDOWS

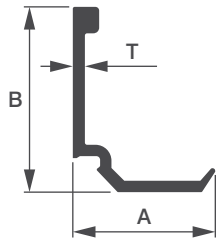

Sl. No.	Sec. No.	A	B	T	Wt. Range KG/12'
1	5601	18.85	24.50	1.60	0.650 - 0.950

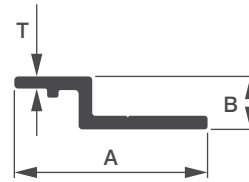

Sl. No.	Sec. No.	A	B	T	Wt. Range KG/12'
1	5602	25.60	7.00	1.60	0.550 - 0.850

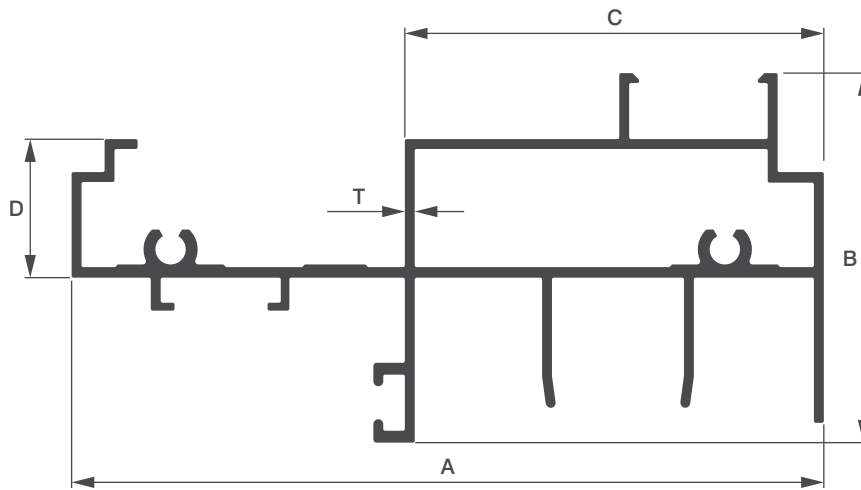

Sl. No.	Sec. No.	A	B	C	D	T	Wt. Range KG/12'
1	5603	114.00	56.00	63.50	21.00	1.50	6.250 - 6.650

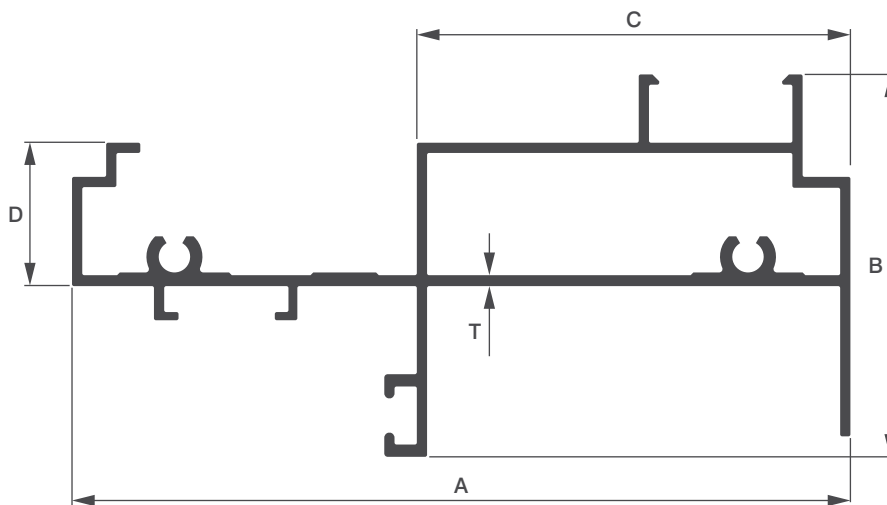

Sl. No.	Sec. No.	A	B	C	D	T	Wt. Range KG/12'
1	5604	114.00	56.00	63.50	21.00	1.60	5.700 - 6.100



CASEMENT WINDOWS

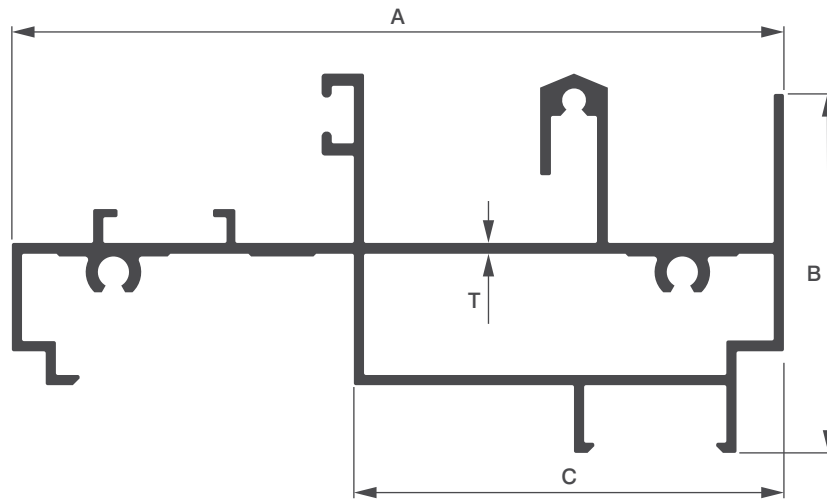

Sl. No.	Sec. No.	A	B	C	T	Wt. Range KG/12'
1	5605	114.00	53.00	63.50	1.60	6.500 - 6.900

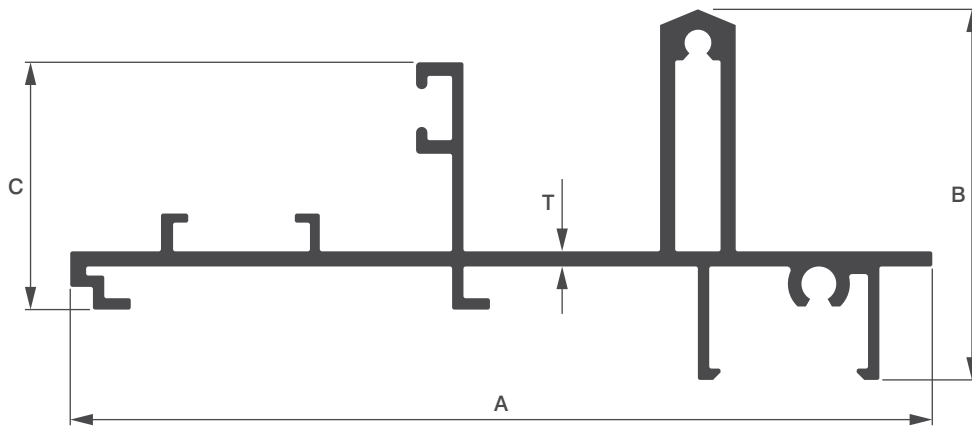

Sl. No.	Sec. No.	A	B	C	T	Wt. Range KG/12'
1	5606	114.00	49.00	32.70	2.00	5.500 - 5.900

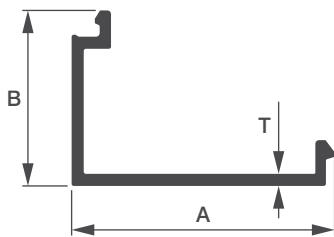

Sl. No.	Sec. No.	A	B	T	Wt. Range KG/12'
1	5607	34.80	23.20	1.60	0.950 - 1.350

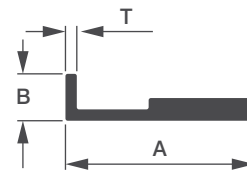

Sl. No.	Sec. No.	A	B	T	Wt. Range KG/12'
1	5610	25.00	6.20	1.50	0.600 - 0.900



CASEMENT WINDOWS

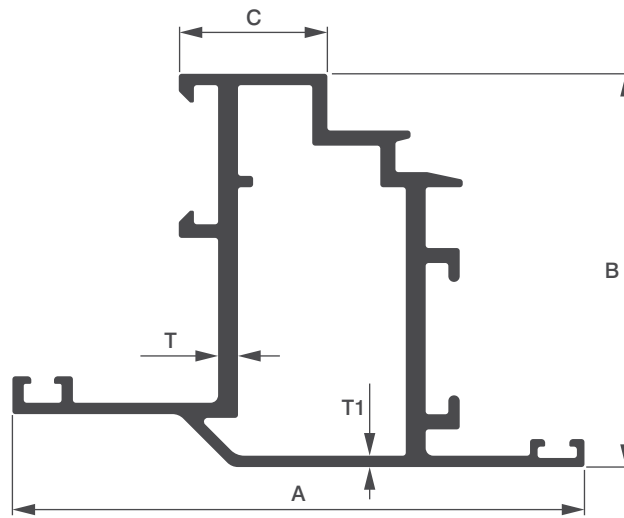

Sl. No.	Sec. No.	A	B	C	T	T1	Wt. Range KG/12'
1	7828	75.65	52.00	19.65	2.63	1.50	4.800 - 5.300

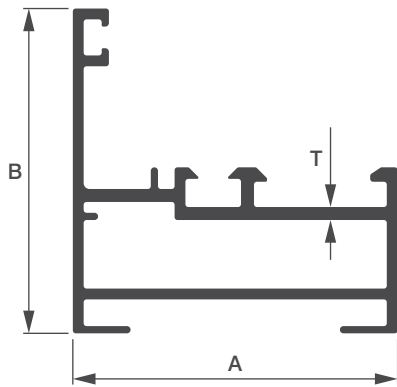

Sl. No.	Sec. No.	A	B	T	Wt. Range KG/12'
1	7826	45.00	45.00	1.80	2.900 - 3.500

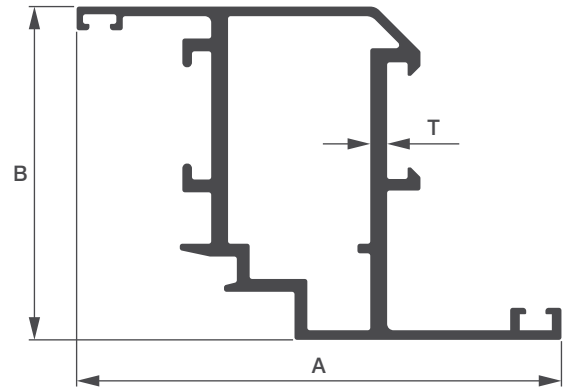

Sl. No.	Sec. No.	A	B	T	Wt. Range KG/12'
1	7827	75.65	52.00	2.63	4.800 - 5.600

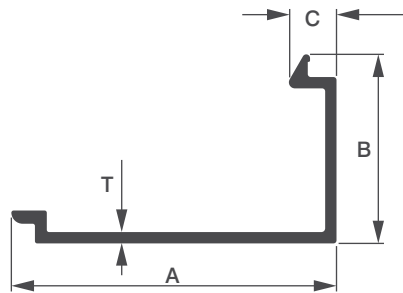

Sl. No.	Sec. No.	A	B	C	T	Wt. Range KG/12'
1	7837	43.00	25.00	6.30	1.50	1.100 - 1.500